

INCLASS

OUTDOOR
Selection

Price list

LEA	p. 10
OSWELL	p. 14
TAIA	p. 18
VARYA	p. 22
BARLIS	p. 30
ESSENS	p. 38
ESSENS OCCASIONAL	p. 52
FLOE	p. 58
LAMINAR	p. 76

CHAIRS & STOOLS

Lea



Chair with 4 leg frame
LEA0012 [prices +](#)



Counter stool with
4 leg frame
LEA0022 [prices +](#)



High stool with
4 leg frame
LEA0032 [prices +](#)

Oswell



Chair with 4 leg frame
(stackable)
OSW0012 [prices +](#)



Counter chair with
4 leg frame
OSW0072 [prices +](#)



High chair with
4 leg frame
OSW0076 [prices +](#)

Taia



Armchair with 4 leg frame
TAI0012 [prices +](#)



Counter armchair
with 4 leg frame
TAI0082 [prices +](#)



High armchair
with 4 leg frame
TAI0087 [prices +](#)

Varya



**Chair with 4 leg frame
(stackable)**
VAR0012 [prices +](#)



**Chair with 4 leg frame
(non stackable)**
VAR0016 [prices +](#)



**Counter chair with
4 leg frame**
VAR0078 [prices +](#)



**High chair with
4 leg frame**
VAR0081 [prices +](#)



**Medium stool
with 4 leg frame**
VAR0071 [prices +](#)



**High stool
with 4 leg frame**
VAR0076 [prices +](#)

TABLES

Barlis



Table base with
height 103cm
BAR0032 [prices +](#)



Table base with
height 73cm
BAR0022 [prices +](#)



Table base with
height 38cm
BAR0012 [prices +](#)



Table tops for bases
[prices +](#)

Essens



Round base 38cm
ES10010BA [prices +](#)



Round base 38cm
stool height
ES10040BA [prices +](#)



Round base 50cm
ES10020BA [prices +](#)



Round base 65cm
ES10050BA [prices +](#)



Elliptical base
ES10060BA [prices +](#)



Oval base
ES10030BA [prices +](#)

Essens occasional



Round base for coffee tables
with height 40cm
ES10110BA [prices +](#)



Round base for side tables
with height 44cm
ES10120BA [prices +](#)



Round base for side tables
with height 52cm
ES10130BA [prices +](#)

Floe cafe



Table base 48x48cm
with height 38cm
FLO0412 [prices +](#)



Table base 48x48cm
with height 73cm
FLO0422 [prices +](#)



Table base 48x48cm
with height 103cm
FLO0432 [prices +](#)



Table tops for
bases 48x48cm
[prices +](#)

Floe occasional



Side table 40x40cm
with height 40cm
FLO0012 [prices +](#)



Side table 50x50cm
with height 40cm
FLO0022 [prices +](#)



Side table 51x38cm
with height 40cm
FLO0032 [prices +](#)



Side table 40x40cm
with height 50cm
FLO0112 [prices +](#)



Side table 50x50cm
with height 50cm
FLO0122 [prices +](#)



Side table 51x38cm
with height 50cm
FLO0132 [prices +](#)



Side table 58x36cm
with height 66cm
FLO00342 [prices +](#)

Laminar



Round tables
[prices +](#)



Tables with individual table tops
[prices +](#)

FINISHES [+info](#)

Polypropylene seats & backs (UV resistant)



Stainless steel frames

M1 colours



M2 colours

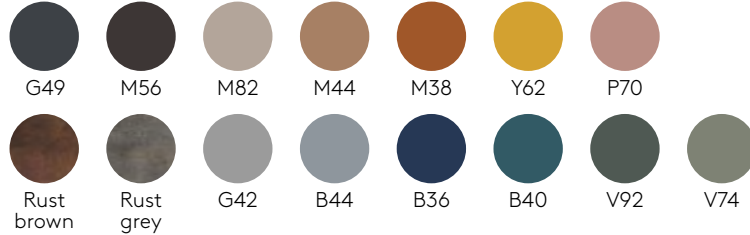

TECHNICAL INFORMATION

Product data sheet [+info](#)

ENVIRONMENT & HEALTH

INCLASS production processes are certified according to environmental standards ISO 14001 in order to minimise any impact on the environment. ISO 14001 certificate [+info](#)



The products marked achieved GREENGUARD Gold Certification with all the fabrics from G1 to G7 [+info](#)

FIRE REQUIREMENTS

Please contact our Customer Service department if your project has specific flammability needs or if you need to know if all components comply with the required standards.

QUALITY STANDARDS

The quality management system of INCLASS is certified in accordance with ISO 9001 in all the design, manufacturing and sales procedures of its products. ISO 9001 certificate [+info](#)

PRODUCT CERTIFICATIONS

UNE-EN 16139:2013vc2015

ANSI/BIFMA X5.4:2020

INCLASS products have been extensively tested to exceed industry testing standards at AIDIMME. AIDIMME is member of the European network INNOVAWOOD and its testing laboratories are accredited by ENAC.

COMPANY CERTIFICATIONS & ACCREDITATIONS

ISO 9001 - Quality management systems

ISO 14001 - Environmental management systems

FSC® - The mark of responsible forestry. Certificate C194846

AIDIMME Partner - Metal-processing, furniture, wood and packaging technology institute

IBV Partner - Valencia Institute of Biomechanics

ADVC Membership - Association of Designers of the Valencian Community

ENVALORA Membership - Collective System of Extended Producer Responsibility

WARRANTY 3 YEARS

Warranty conditions [+info](#)

+ INFO: <https://inclass.es/collection/lea-outdoor/>

All prices listed in €. Taxes not included

Chair with 4 leg frame in stainless steel



Stackable chair with seat and back in polypropylene. Four leg frame in round stainless steel tube.

Remark: minimum order 2 units.

Seat and back finishes: surface with a matt non-slip micro-texture. Available in colours PP1 from the polypropylene swatch card. Made of UV resistant polypropylene.

Frame finishes: micro-textured powder coated in colours M1 and M2 from our metallic swatch card.

Glides: plastic glides as standard.



Product with GREENGUARD Gold Certificate.

[Finishes book +info](#)

Code	Frame	€
LEA0012	Colours M1	238
LEA0012	Colours M2	248

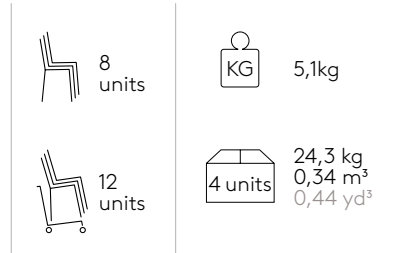
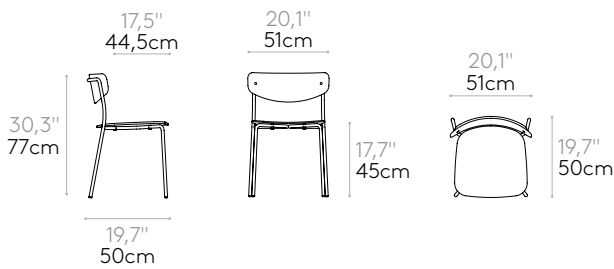

* Numbers may vary based on the exact options selected.

Medium stool with 4 leg frame in stainless steel



Stackable counter stool with seat and back in polypropylene. Four leg frame in round stainless steel tube and footrest in steel rod.

Remark: this stool is only available in multiples of two units.

Seat and back finishes: surface with a matt non-slip micro-texture. Available in colours PP1 from the polypropylene swatch card. Made of UV resistant polypropylene.

Frame finishes: micro-textured powder coated in colours M1 and M2 from our metallic swatch card.

Glides: plastic glides as standard.



Product with GREENGUARD Gold Certificate.

[Finishes book +info](#)

Code	Frame	€
LEA0022	Colours M1	302
LEA0022	Colours M2	312

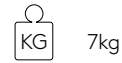
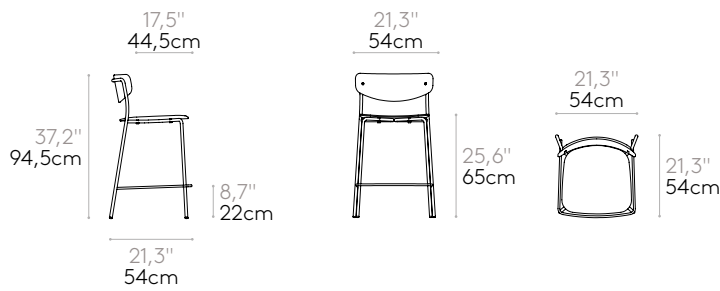

* Numbers may vary based on the exact options selected.

All prices listed in €. Taxes not included

High stool with 4 leg frame in stainless steel



Stackable high stool with seat and back in polypropylene. Four leg frame in round stainless steel tube and footrest in steel rod.

Remark: this stool is only available in multiples of two units.

Seat and back finishes: surface with a matt non-slip micro-texture. Available in colours PP1 from the polypropylene swatch card. Made of UV resistant polypropylene.

Frame finishes: micro-textured powder coated in colours M1 and M2 from our metallic swatch card.

Glides: plastic glides as standard.



Product with GREENGUARD Gold Certificate.

[Finishes book +info](#)

Code	Frame	€
LEA0032	Colours M1	328
LEA0032	Colours M2	338

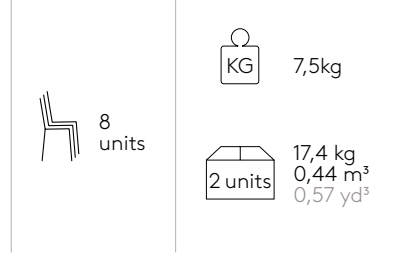
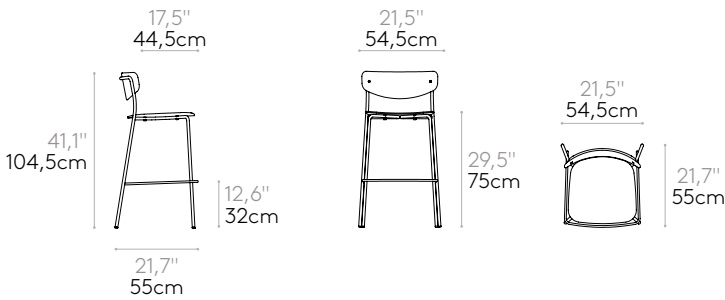

* Numbers may vary based on the exact options selected.

OSWELL

FINISHES [+info](#)

Polypropylene seat shells (UV resistant)

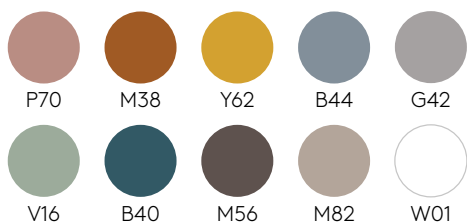

Ecoplas® seat shells (UV resistant) (100% recycled polypropylene)

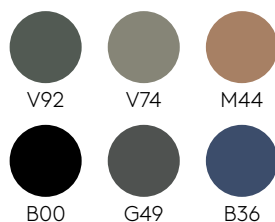

Stainless steel frames

M1 colours



M2 colours

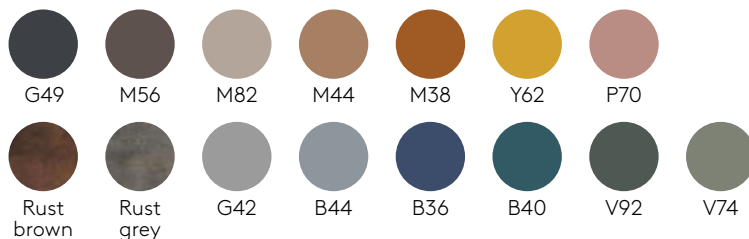

TECHNICAL INFORMATION

Product data sheet [+info](#)

ENVIRONMENT & HEALTH

INCLASS production processes are certified according to environmental standards ISO 14001 in order to minimise any impact on the environment. ISO 14001 certificate [+info](#)



The products marked achieved GREENGUARD Gold Certification with all the fabrics from G1 to G7 [+info](#)

FIRE REQUIREMENTS

Please contact our Customer Service department if your project has specific flammability needs or if you need to know if all components comply with the required standards.

QUALITY STANDARDS

The quality management system of INCLASS is certified in accordance with ISO 9001 in all the design, manufacturing and sales procedures of its products. ISO 9001 certificate [+info](#)

COMPANY CERTIFICATIONS & ACCREDITATIONS

ISO 9001 - Quality management systems

ISO 14001 - Environmental management systems

FSC® - The mark of responsible forestry. Certificate C194846

AIDIMME Partner - Metal-processing, furniture, wood and packaging technology institute

IBV Partner - Valencia Institute of Biomechanics

ADVC Membership - Association of Designers of the Valencian Community

ENVALORA Membership - Collective System of Extended Producer Responsibility

WARRANTY 3 YEARS

Warranty conditions [+info](#)

+ INFO: <https://inclass.es/collection/oswell-outdoor/>

All prices listed in €. Taxes not included

Chair with 4 leg frame in stainless steel (stackable)



Stackable chair with polypropylene seat shell and round steel tube 4 leg frame. The frame is made of round stainless steel tube.

Shell finishes: surface with a matt non-slip micro-texture. Available in colours PP1 from the polypropylene swatch card. Made of UV resistant polypropylene. Custom colours available for minimum orders of 500 pcs.

Frame finishes: micro-textured powder coated in colours M1 and M2 from our metallic swatch card.

Glides: plastic glides as standard.



Product with GREENGUARD Gold Certificate.

Finishes book [+info](#)

Code	Frame	€
OSW0012	Colours M1	227
OSW0012	Colours M2	233

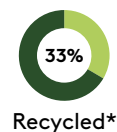
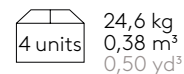
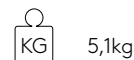
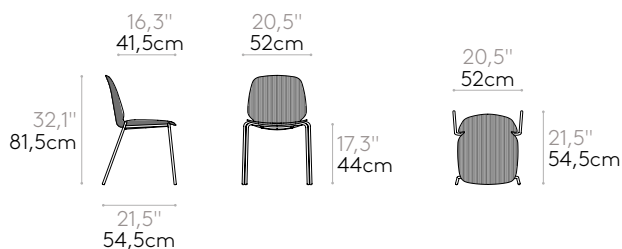

* Numbers may vary based on the exact options selected.

OSWELL

Counter chair with 4 leg frame in stainless steel



Stackable counter chair with polypropylene seat shell and round steel tube 4 leg frame. The frame is made of round stainless steel tube.

Shell finishes: surface with a matt non-slip micro-texture. Available in colours PP1 from the polypropylene swatch card. Made of UV resistant polypropylene. Custom colours available for minimum orders of 500 pcs.

Frame finishes: micro-textured powder coated in colours M1 and M2 from our metallic swatch card.

Glides: plastic glides as standard.



Product with GREENGUARD Gold Certificate.

[Finishes book +info](#)

Code	Frame	€
OSW0072	Colours M1	310
OSW0072	Colours M2	320

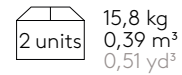
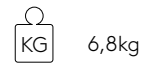
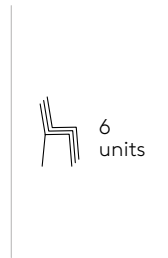
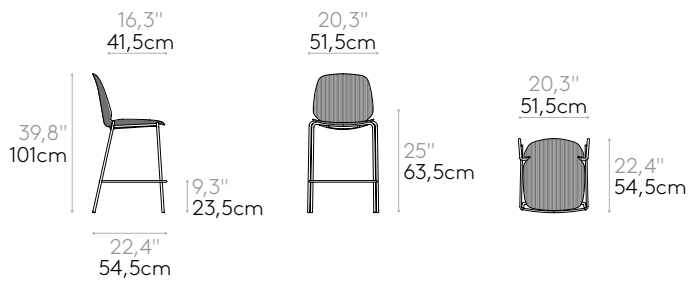

* Numbers may vary based on the exact options selected.

All prices listed in €. Taxes not included

High chair with 4 leg frame in stainless steel



Stackable high chair with polypropylene seat shell and round steel tube 4 leg frame. The frame is made of round stainless steel tube.

Shell finishes: surface with a matt non-slip micro-texture. Available in colours PP1 from the polypropylene swatch card. Made of UV resistant polypropylene. Custom colours available for minimum orders of 500 pcs.

Frame finishes: micro-textured powder coated in colours M1 and M2 from our metallic swatch card.

Glides: plastic glides as standard.



Product with GREENGUARD Gold Certificate.

[Finishes book +info](#)

Code	Frame	€
OSW0076	Colours M1	322
OSW0076	Colours M2	332

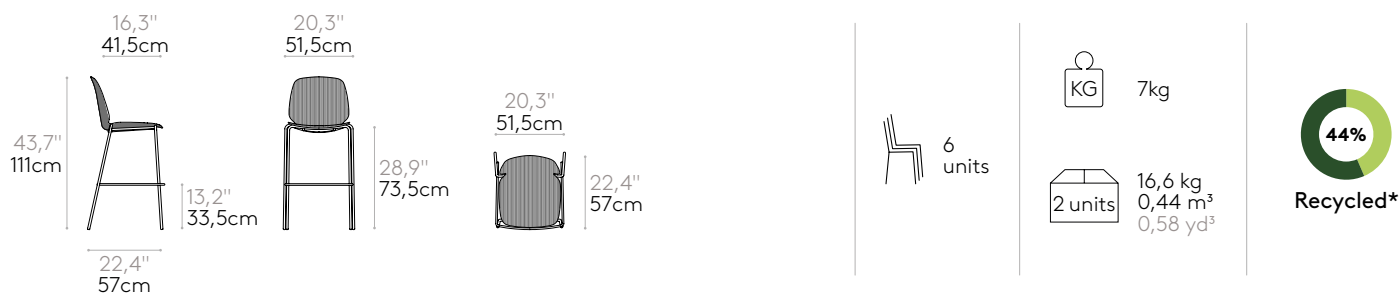

* Numbers may vary based on the exact options selected.

FINISHES [+info](#)

Polypropylene seat shells (UV resistant)

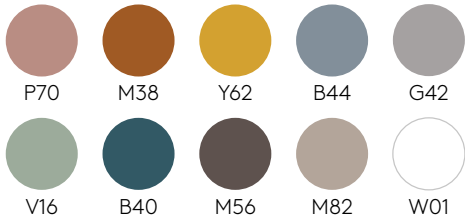

Ecoplas® seat shells (UV resistant) (100% recycled polypropylene)

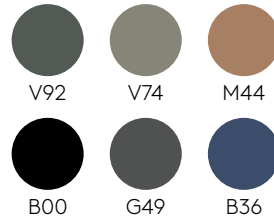

Stainless steel frames

M1 colours



M2 colours

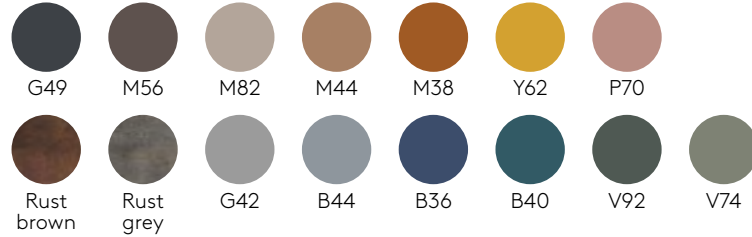

TECHNICAL INFORMATION

Product data sheet [+info](#)

ENVIRONMENT & HEALTH

INCLASS production processes are certified according to environmental standards ISO 14001 in order to minimise any impact on the environment. ISO 14001 certificate [+info](#)



The products marked achieved GREENGUARD Gold Certification with all the fabrics from G1 to G7 [+info](#)

FIRE REQUIREMENTS

Please contact our Customer Service department if your project has specific flammability needs or if you need to know if all components comply with the required standards.

QUALITY STANDARDS

The quality management system of INCLASS is certified in accordance with ISO 9001 in all the design, manufacturing and sales procedures of its products. ISO 9001 certificate [+info](#)

PRODUCT CERTIFICATIONS

UNE-EN 16139:2013vc2015

ANSI/BIFMA X5.4:2012

INCLASS products have been extensively tested to exceed industry testing standards at AIDIMME. AIDIMME is member of the European network INNOVAWOOD and its testing laboratories are accredited by ENAC.

COMPANY CERTIFICATIONS & ACCREDITATIONS

ISO 9001 - Quality management systems

ISO 14001 - Environmental management systems

FSC® - The mark of responsible forestry. Certificate C194846

AIDIMME Partner - Metal-processing, furniture, wood and packaging technology institute

IBV Partner - Valencia Institute of Biomechanics

ADVC Membership - Association of Designers of the Valencian Community

ENVALORA Membership - Collective System of Extended Producer Responsibility

WARRANTY 3 YEARS

Warranty conditions [+info](#)

+ INFO: <https://inclass.es/collection/taia-outdoor/>

All prices listed in €. Taxes not included

Armchair with 4 leg frame in stainless steel



Armchair with polypropylene shell and 4 leg frame. The frame is made of round stainless steel tube.

Shell finishes: surface with a matt non-slip micro-texture. Available in colours PP1 from the polypropylene swatch card. Made of UV resistant polypropylene. Custom colours available for minimum orders of 300 pcs.

Frame finishes: micro-textured powder coated in colours M1 and M2 from our metallic swatch card.

Glides: plastic glides as standard.



Product with GREENGUARD Gold Certificate.

Finishes book [+info](#)

Code	Frame	€
TAI0012	Colours M1	243
TAI0012	Colours M2	250



KG 5,4kg

1 unit 8 kg
0,31 m³
0,41 yd³



* Numbers may vary based on the exact options selected.

TAIA

Counter armchair with 4 leg frame in stainless steel



Counter armchair with polypropylene shell and round steel tube 4 leg frame. The frame is made of round stainless steel tube.

Shell finishes: surface with a matt non-slip micro-texture. Available in colours PP1 from the polypropylene swatch card. Made of UV resistant polypropylene. Custom colours available for minimum orders of 300 pcs.

Frame finishes: micro-textured powder coated in colours M1 and M2 from our metallic swatch card.

Glides: plastic glides as standard.



Product with GREENGUARD Gold Certificate.

[Finishes book +info](#)

Code	Frame	€
TAI0082	Colours M1	343
TAI0082	Colours M2	353

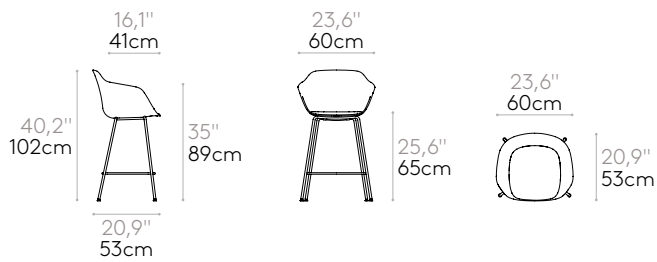

KG 7,3kg

1 unit 9,9 kg
0,31 m³
0,41 yd³
KD

38%
Recycled*

* Numbers may vary based on the exact options selected.

All prices listed in €. Taxes not included

High armchair with 4 leg frame in stainless steel



High armchair with polypropylene shell and round steel tube 4 leg frame. The frame is made of round stainless steel tube.

Shell finishes: surface with a matt non-slip micro-texture. Available in colours PP1 from the polypropylene swatch card. Made of UV resistant polypropylene. Custom colours available for minimum orders of 300 pcs.

Frame finishes: micro-textured powder coated in colours M1 and M2 from our metallic swatch card.

Glides: plastic glides as standard.



Product with GREENGUARD Gold Certificate.

Finishes book [+info](#)

Code	Frame	€
TAI0087	Colours M1	345
TAI0087	Colours M2	355

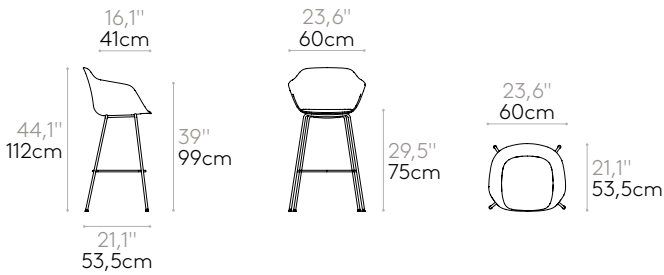

KG 7,5kg

1 unit
KD
10,11 kg
0,31 m³
0,41 yd³

39%
Recycled*

* Numbers may vary based on the exact options selected.

VARYA

FINISHES [+info](#)

Polypropylene seat shells (UV resistant)

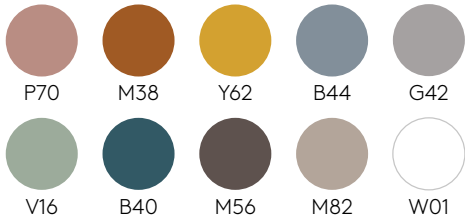

Ecoplas® seat shells (UV resistant) (100% recycled polypropylene)



Stainless steel frames

M1 colours



M2 colours

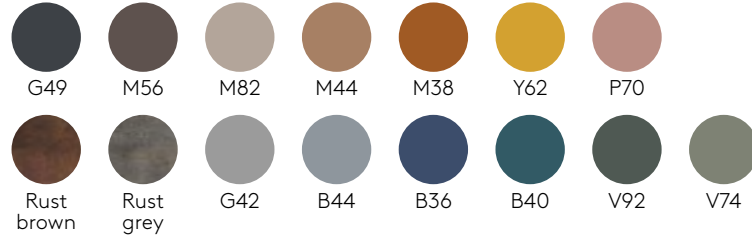

TECHNICAL INFORMATION

Product data sheet [+info](#)

ENVIRONMENT & HEALTH

INCLASS production processes are certified according to environmental standards ISO 14001 in order to minimise any impact on the environment. ISO 14001 certificate [+info](#)



The products marked achieved GREENGUARD Gold Certification with all the fabrics from G1 to G7 [+info](#)

FIRE REQUIREMENTS

Please contact our Customer Service department if your project has specific flammability needs or if you need to know if all components comply with the required standards.

QUALITY STANDARDS

The quality management system of INCLASS is certified in accordance with ISO 9001 in all the design, manufacturing and sales procedures of its products. ISO 9001 certificate [+info](#)

PRODUCT CERTIFICATIONS

UNE-EN 16139:2013vc2015

ANSI/BIFMA X5.4:2012

INCLASS products have been extensively tested to exceed industry testing standards at AIDIMME. AIDIMME is member of the European network INNOVAWOOD and its testing laboratories are accredited by ENAC.

COMPANY CERTIFICATIONS & ACCREDITATIONS

ISO 9001 - Quality management systems

ISO 14001 - Environmental management systems

FSC® - The mark of responsible forestry. Certificate C194846

AIDIMME Partner - Metal-processing, furniture, wood and packaging technology institute

IBV Partner - Valencia Institute of Biomechanics

ADVC Membership - Association of Designers of the Valencian Community

ENVALORA Membership - Collective System of Extended Producer Responsibility

WARRANTY 3 YEARS

Warranty conditions [+info](#)

+Info: <https://inclass.es/collection/varya-outdoor/>

All prices listed in €. Taxes not included

Chair with 4 leg frame in stainless steel (stackable)



Stackable chair with polypropylene seat shell and round steel tube 4 leg frame. The frame is made of round stainless steel tube.

Shell finishes: surface with a matt non-slip micro-texture. Available in colours PP1 from the polypropylene swatch card. Made of UV resistant polypropylene. Custom colours available for minimum orders of 500 pcs.

Frame finishes: micro-textured powder coated in colours M1 and M2 from our metallic swatch card.

Glides: plastic glides as standard.



Product with GREENGUARD Gold Certificate.

[Finishes book +info](#)

Code	Frame	€
VAR0012	Colours M1	203
VAR0012	Colours M2	210

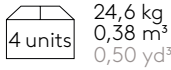
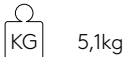
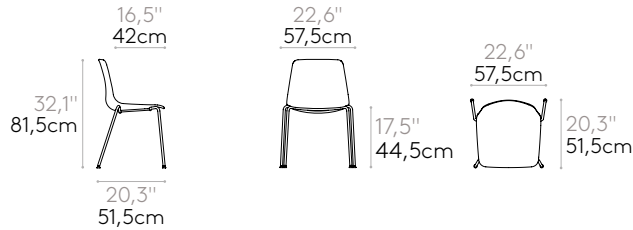

* Numbers may vary based on the exact options selected.

VARYA

Chair with 4 leg frame in stainless steel (non stackable)



Chair with polypropylene seat shell and round steel tube 4 leg frame. The frame is made of round stainless steel tube.

Shell finishes: surface with a matt non-slip micro-texture. Available in colours PP1 from the polypropylene swatch card. Made of UV resistant polypropylene. Custom colours available for minimum orders of 500 pcs.

Frame finishes: micro-textured powder coated in colours M1 and M2 from our metallic swatch card.

Glides: plastic glides as standard.



Product with GREENGUARD Gold Certificate.

[Finishes book +info](#)

Code	Frame	€
VAR0016	Colours M1	200
VAR0016	Colours M2	207

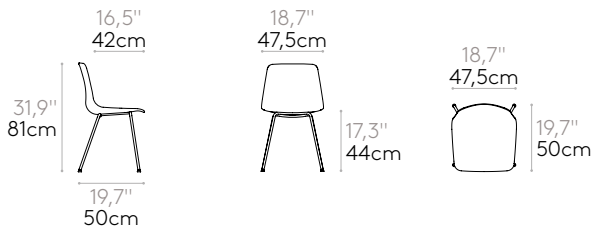

4,7kg



13,3 kg
0,38 m³
0,50 yd³



Recycled*

* Numbers may vary based on the exact options selected.

All prices listed in €. Taxes not included

Counter chair with 4 leg frame in stainless steel



Counter chair with polypropylene seat shell and round steel tube 4 leg frame. The frame is made of round stainless steel tube.

Shell finishes: surface with a matt non-slip micro-texture. Available in colours PP1 from the polypropylene swatch card. Made of UV resistant polypropylene. Custom colours available for minimum orders of 500 pcs.

Frame finishes: micro-textured powder coated in colours M1 and M2 from our metallic swatch card.

Glides: plastic glides as standard.



Product with GREENGUARD Gold Certificate.

[Finishes book +info](#)

Code	Frame	€
VAR0078	Colours M1	270
VAR0078	Colours M2	280

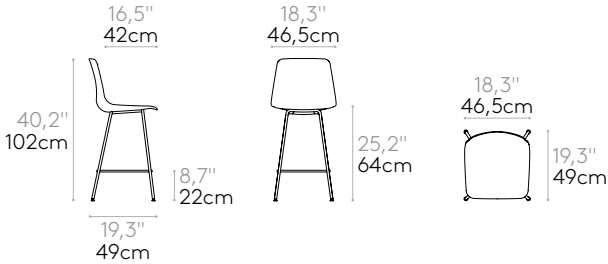

KG 6,6kg

1 unit 8,6 kg, 0,19 m³, 0,24 yd³

KD

45% Recycled*

* Numbers may vary based on the exact options selected.

VARYA

High chair with 4 leg frame in stainless steel



High chair with polypropylene seat shell and round steel tube 4 leg frame. The frame is made of round stainless steel tube.

Shell finishes: surface with a matt non-slip micro-texture. Available in colours PP1 from the polypropylene swatch card. Made of UV resistant polypropylene. Custom colours available for minimum orders of 500 pcs.

Frame finishes: micro-textured powder coated in colours M1 and M2 from our metallic swatch card.

Glides: plastic glides as standard.



Product with GREENGUARD Gold Certificate.

[Finishes book +info](#)

Code	Frame	€
VAR0081	Colours M1	298
VAR0081	Colours M2	308

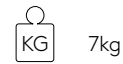
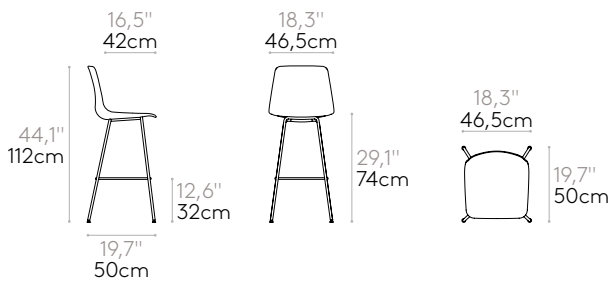

* Numbers may vary based on the exact options selected.

All prices listed in €. Taxes not included

Medium stool with 4 leg frame in stainless steel



Medium stool with polypropylene seat shell and round steel tube 4 leg frame. The frame is made of round stainless steel tube.

Shell finishes: surface with a matt non-slip micro-texture. Available in colours PP1 from the polypropylene swatch card. Made of UV resistant polypropylene. Custom colours available for minimum orders of 500 pcs.

Frame finishes: micro-textured powder coated in colours M1 and M2 from our metallic swatch card.

Glides: plastic glides as standard.



Product with GREENGUARD Gold Certificate.

[Finishes book +info](#)

Code	Frame	€
VAR0071	Colours M1	252
VAR0071	Colours M2	262

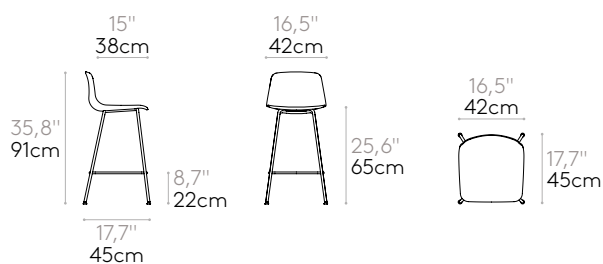

KG 5,6kg

1 unit 7,9 kg
0,26 m³
0,34 yd³

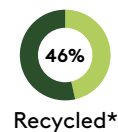

* Numbers may vary based on the exact options selected.

VARYA

High stool with 4 leg frame in stainless steel



High stool with polypropylene seat shell and round steel tube 4 leg frame. The frame is made of round stainless steel tube.

Shell finishes: surface with a matt non-slip micro-texture. Available in colours PP1 from the polypropylene swatch card. Made of UV resistant polypropylene. Custom colours available for minimum orders of 500 pcs.

Frame finishes: micro-textured powder coated in colours M1 and M2 from our metallic swatch card.

Glides: plastic glides as standard.



Product with GREENGUARD Gold Certificate.

[Finishes book +info](#)

Code	Frame	€
VAR0076	Colours M1	280
VAR0076	Colours M2	290

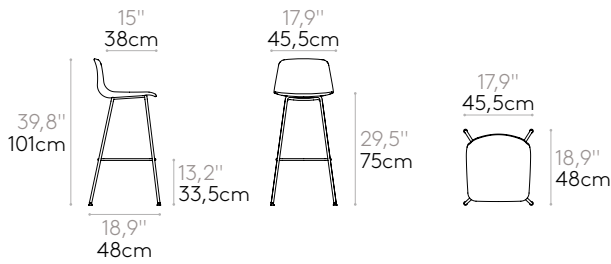

KG 5,9kg

1 unit 8,2 kg
0,29 m³
0,38 yd³

49%
Recycled*

* Numbers may vary based on the exact options selected.

All prices listed in €. Taxes not included

BARLIS

FINISHES +info

Base finishes

M1 colours

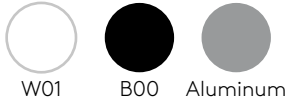

M2 colours

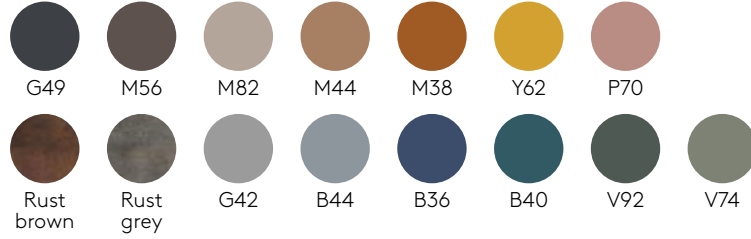

Table tops

Solid FENIX®

12mm black core



Black

Solid HPL

12mm black core



White



Black

Solid HPL

12mm white core



White

Solid HPL

12mm sand core



Sand

Solid HPL STONES

12mm

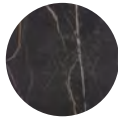

Dark brown
Samas
3482



Light brown
Pulpis
3447



White
Olimpo
3493

TECHNICAL INFORMATION

Product data sheet [+info](#)

ENVIRONMENT & HEALTH

INCLASS production processes are certified according to environmental standards ISO 14001 in order to minimise any impact on the environment. ISO 14001 certificate [+info](#)

FIRE REQUIREMENTS

Please contact our Customer Service department if your project has specific flammability needs or if you need to know if all components comply with the required standards.

QUALITY STANDARDS

The quality management system of INCLASS is certified in accordance with ISO 9001 in all the design, manufacturing and sales procedures of its products. ISO 9001 certificate [+info](#)

COMPANY CERTIFICATIONS & ACCREDITATIONS

ISO 9001 - Quality management systems

ISO 14001 - Environmental management systems

FSC® - The mark of responsible forestry. Certificate C194846

AIDIMME Partner - Metal-processing, furniture, wood and packaging technology institute

IBV Partner - Valencia Institute of Biomechanics

ADVC Membership - Association of Designers of the Valencian Community

ENVALORA Membership - Collective System of Extended Producer Responsibility

WARRANTY 3 YEARS

Warranty conditions [+info](#)

BARLIS

Table base with height 103cm (top not included)

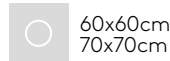
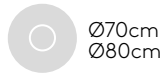

Table base with central column in steel tube and 4 spoke base made of cast aluminum alloy. Height 103cm.

Base finishes: micro-textured powder coated in colours M1 and M2 from our metallic swatch card.

Glides: plastic glides as standard.

Finishes book [+info](#)

Code	Base	€
BAR0032	Colours M1	259
BAR0032	Colours M2	285

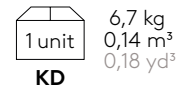
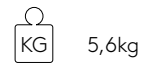
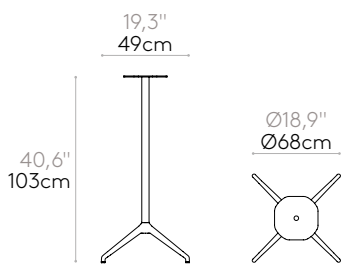

Table base with height 103cm and mechanism for flip top (top not included)

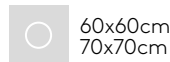
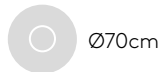

Table base with mechanism for flip table, central column in steel tube and 4 spoke base made of cast aluminum alloy. Height 103cm.

Base finishes: micro-textured powder coated in colours M1 and M2 from our metallic swatch card.

Glides: plastic glides as standard.

Finishes book [+info](#)

Code	Base	€
BAR0132	Colours M1	305
BAR0132	Colours M2	336

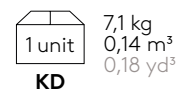
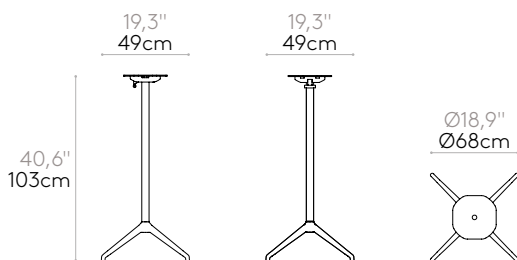

* Numbers may vary based on the exact options selected.

All prices listed in €. Taxes not included

Table base with height 73cm (top not included)

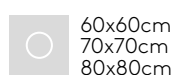

Table base with central column in steel tube and 4 spoke base made of cast aluminum alloy. Height 73cm.

Base finishes: micro-textured powder coated in colours M1 and M2 from our metallic swatch card.

Glides: plastic glides as standard.

Finishes book [+info](#)

Code	Base	€
BAR0022	Colours M1	241
BAR0022	Colours M2	265

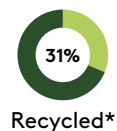
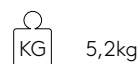
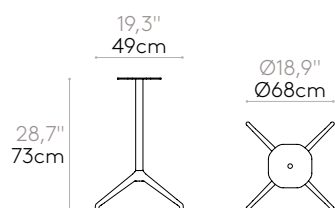

Table base with height 73cm and mechanism for flip top (top not included)

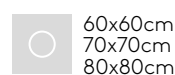
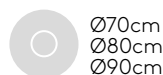

Table base with mechanism for flip table, central column in steel tube and 4 spoke base made of cast aluminum alloy. Height 73cm.

Base finishes: micro-textured powder coated in colours M1 and M2 from our metallic swatch card.

Glides: plastic glides as standard.

Finishes book [+info](#)

Code	Base	€
BAR0122	Colours M1	289
BAR0122	Colours M2	318

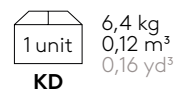
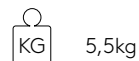
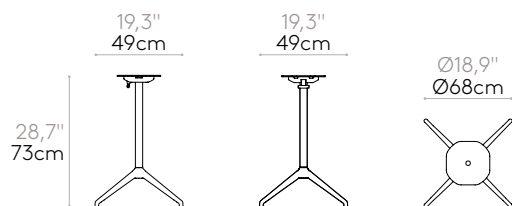

* Numbers may vary based on the exact options selected.

BARLIS

Table base with height 38cm (top not included)

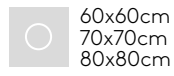
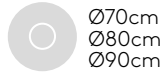

Table base with central column in steel tube and 4 spoke base made of cast aluminum alloy. Height 38cm.

Base finishes: micro-textured powder coated in colours M1 and M2 from our metallic swatch card.

Glides: plastic glides as standard.

Finishes book [+info](#)

Code	Base	€
BAR0012	Colours M1	226
BAR0012	Colours M2	249

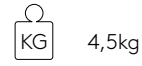
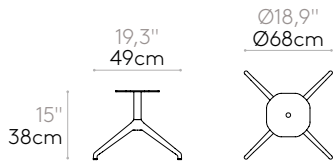

4,5kg



6,1 kg
0,17 m³
0,22 yd³



Recycled*

* Numbers may vary based on the exact options selected.





All prices listed in €. Taxes not included

Round table tops



Top size	70cm	80cm	90cm
Code	TAP0070TP	TAP0080TP	TAP0090TP
Solid HPL 12mm** black core	242	279	326
Solid FENIX® 12mm** black / black core	512	593	698
Solid HPL 12mm** white / white core sand / sand core	512	593	698
Solid HPL STONES 12mm**	563	653	768

Table tops shipping data

Top size	70cm	80cm	90cm
Code	TAP0070TP	TAP0080TP	TAP0090TP
Solid HPL 12mm** black core	6,5 kg	8,5 kg	10,5kg
	7,5 kg 0,04 m ³ 0,05 yd ³	10,0 kg 0,05 m ³ 0,06 yd ³	11,9 kg 0,06 m ³ 0,08 yd ³
Solid FENIX® 12mm** black / black core	6,5 kg	8,5 kg	11kg
	7,5 kg 0,04 m ³ 0,05 yd ³	10,0 kg 0,05 m ³ 0,06 yd ³	12,4 kg 0,06 m ³ 0,08 yd ³
Solid HPL 12mm** white / white core sand / sand core	6,5 kg	8,5 kg	10,5kg
	7,5 kg 0,04 m ³ 0,05 yd ³	10,0 kg 0,05 m ³ 0,06 yd ³	11,9 kg 0,06 m ³ 0,08 yd ³
Solid HPL STONES 12mm**	6,5 kg	8,5 kg	10,5kg
	7,5 kg 0,04 m ³ 0,05 yd ³	10,0 kg 0,05 m ³ 0,06 yd ³	11,9 kg 0,06 m ³ 0,08 yd ³

** The size of the HPL tops may have variations of ±1mm.







BARLIS

Square table tops



Top size	60x60cm	70x70cm	80x80cm	
Top finish	Code	TAP0606TP	TAP0707TP	TAP0808TP
Solid HPL 12mm** black core	208	244	282	
Solid FENIX® 12mm** black / black core	410	521	595	
Solid HPL 12mm** white / white core sand / sand core	410	521	595	
Solid HPL STONES 12mm**	451	574	655	

Table tops shipping data

Top size	60x60cm	70x70cm	80x80cm
Code	TAP0606TP	TAP0707TP	TAP0808TP
	6kg	8kg	10,5kg
Solid HPL 12mm* black core	6,8 kg 0,03 m ³ 0,04 yd ³	9,0 kg 0,04 m ³ 0,05 yd ³	12,0 kg 0,05 m ³ 0,06 yd ³
			
Solid FENIX® 12mm* black / black core	6,8 kg 0,03 m ³ 0,04 yd ³	9,5 kg 0,04 m ³ 0,05 yd ³	12,5 kg 0,05 m ³ 0,06 yd ³
	6kg	8,5kg	11kg
Solid HPL 12mm* white / white core sand / sand core	6,8 kg 0,03 m ³ 0,04 yd ³	9,0 kg 0,04 m ³ 0,05 yd ³	12,0 kg 0,05 m ³ 0,06 yd ³
			
Solid HPL STONES 12mm*	6,8 kg 0,03 m ³ 0,04 yd ³	9,0 kg 0,04 m ³ 0,05 yd ³	12,0 kg 0,05 m ³ 0,06 yd ³
	6kg	8kg	10,5kg
			

** The size of the HPL tops may have variations of ±1mm.

All prices listed in €. Taxes not included

Rectangular table tops





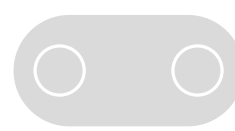





Oval table top



	Top size	140x70cm	160x80cm	180x90cm
Top finish	Code	TAP1407TP	TAP1608TP	TAP1809TO

Solid HPL 12mm** black core		522	569	703
Solid FENIX® 12mm** black / black core		1.039	1.131	1.468
Solid HPL 12mm** white / white core sand / sand core		1.039	1.131	1.468
Solid HPL STONES 12mm**		1.143	1.244	1.615

Table tops shipping data

	Top size	140x70cm	160x80cm	180x90cm
	Code	TAP1407TP	TAP1608TP	TAP1809TO
Solid HPL 12mm** black core	 	15,9 kg 25,3 kg 0,07 m ³ 0,09 yd ³	21 kg 32,6 kg 0,09 m ³ 0,12 yd ³	23,5 kg 30,6 kg 0,20 m ³ 0,26 yd ³
Solid FENIX® 12mm** black core	 	16,5 kg 25,9 kg 0,07 m ³ 0,09 yd ³	21,5 kg 33,1 kg 0,09 m ³ 0,12 yd ³	24,5 kg 31,6 kg 0,20 m ³ 0,26 yd ³
Solid HPL 12mm** white / white core sand / sand core	 	15,9 kg 25,3 kg 0,07 m ³ 0,09 yd ³	21 kg 32,6 kg 0,09 m ³ 0,12 yd ³	23,5 kg 30,6 kg 0,20 m ³ 0,26 yd ³
Solid HPL STONES 12mm**	 	15,9 kg 25,3 kg 0,07 m ³ 0,09 yd ³	21 kg 32,6 kg 0,09 m ³ 0,12 yd ³	23,5 kg 30,6 kg 0,20 m ³ 0,26 yd ³

** The size of the HPL tops may have variations of ±1mm.

ESSENS

FINISHES +info

Rotomolded polyethylene colours

PE1 colours

standard colours



B00* black G49 anthracite G42 grey M82 stone W01 white

*B00 black 100% recycled material

PE2 colours

composed colours

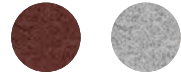

Rust brown Concrete

PE3 colours

standard painted colours



B40* V92* V74* Y62* M38*



B36* B44* P70* M44* M56*

*100% recycled material

PE4 colours

metallic painted colours



Silver Gold Copper

PE5 colours

bespoke painted colours

OPTIONALLY, the bases can be painted in all the colours of the RAL sample card, both in gloss and matt finish.

Table tops

Solid FENIX®

12mm black core



Black

Solid HPL

12mm black core



White



Black

Solid HPL

12mm white core



White

Solid HPL

12mm sand core



Sand

Solid HPL STONES

12mm

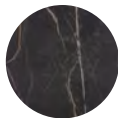

Dark brown
Samas
3482



Light brown
Pulpis
3447

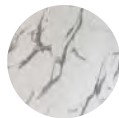

White
Olimpo
3493

TECHNICAL INFORMATION

Product data sheet [+info](#)

ENVIRONMENT & HEALTH

Product environmental data sheet [+info](#)

INCLASS production processes are certified according to environmental standards ISO 14001 in order to minimise any impact on the environment. ISO 14001 certificate [+info](#)

FIRE REQUIREMENTS

Please contact our Customer Service department if your project has specific flammability needs or if you need to know if all components comply with the required standards.

QUALITY STANDARDS

The quality management system of INCLASS is certified in accordance with ISO 9001 in all the design, manufacturing and sales procedures of its products. ISO 9001 certificate [+info](#)

PRODUCT CERTIFICATIONS

UNE-EN 15372:2017

ANSI/SOHO S6.5:2008

INCLASS products have been extensively tested to exceed industry testing standards at AIDIMME. AIDIMME is member of the European network INNOVAWOOD and its testing laboratories are accredited by ENAC.

COMPANY CERTIFICATIONS & ACCREDITATIONS

ISO 9001 - Quality management systems

ISO 14001 - Environmental management systems

FSC® - The mark of responsible forestry. Certificate C194846

AIDIMME Partner - Metal-processing, furniture, wood and packaging technology institute

IBV Partner - Valencia Institute of Biomechanics

ADVC Membership - Association of Designers of the Valencian Community

ENVALORA Membership - Collective System of Extended Producer Responsibility

WARRANTY 3 YEARS

Warranty conditions [+info](#)

ESSENS

Round base 38cm (top not included)

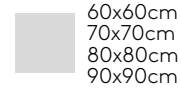
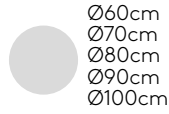

Round polyethylene table base Ø38cm. This base allows to build tables with round tops of up to Ø100cm and square tops of up to 90x90cm. The inner counterweight must be acquired separately.

For this base we recommend a minimum inner counter weight of 40kg.

Finishes: in colours PE1, PE2, PE3 and PE5 from our rothomolded polyethylene swatch card.

Finishes book [+info](#)

Code	Colours PE1 standard	Colours PE2 composed	Colours PE3 standard painted	Colours PE4 metallic painted	Colours PE5 special RAL colours
ES10010BA	286	303	564	589	649

Code	Optional items & accessories	€
ES30012OP	Counterweight 40kg of gravel	36

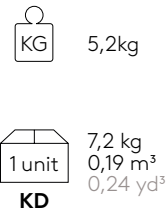
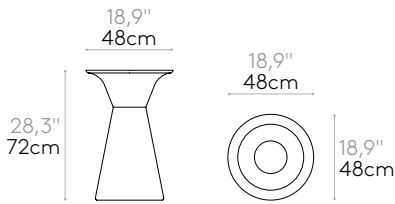

* Numbers may vary based on the exact options selected.
Only bases in B00 (black) and PE3 colours are made of 100% recycled PE.

Round base 38cm stool height (top not included)



Ø60cm
 Ø70cm
 Ø80cm
 Ø90cm

60x60cm
 70x70cm
 80x80cm

Round high polyethylene table base Ø38cm. This base allows to build tables with round tops of up to Ø90cm and square tops of up to 80x80cm. The inner counterweight must be acquired separately.

For this base we recommend a minimum inner counter weight of 40kg.

Finishes: in colours PE1, PE2, PE3 and PE5 from our rothomolded polyethylene swatch card.

Finishes book [+info](#)

Code	Colours PE1 standard	Colours PE2 composed	Colours PE3 standard painted	Colours PE4 metallic painted	Colours PE5 special RAL colours
ES10040BA	354	374	701	733	805

Code	Optional items & accessories	€
ES30012OP	Counterweight 40kg of gravel	36

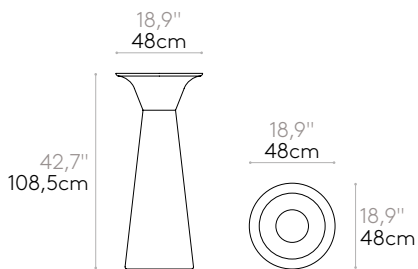

 6,8kg

 9,1 kg
 0,26 m³
 0,34 yd³
KD

 0%
 Recycled*

* Numbers may vary based on the exact options selected.
 Only bases in B00 (black) and PE3 colours are made of 100% recycled PE.

ESSENS

Round table tops (for round base Ø38cm)



Table tops for tables with round bases 38cm.
The prices indicated below are only for the table tops.

Top size	60cm	70cm	80cm	90cm	100cm	
Top material	Code	ES20060TP	ES20070TP	ES20080TP	ES20090TP	ES20100TP
Solid HPL 12mm** black core	208	242	279	326	396	
Solid FENIX® 12mm** black / black core	408	512	593	698	871	
Solid HPL 12mm** white / white core sand / sand core	408	512	593	698	871	
Solid HPL STONES 12mm**	449	563	653	768	959	

Table tops shipping data

Top size	60cm	70cm	80cm	90cm	100cm	
Top material	Code	ES20060TP	ES20070TP	ES20080TP	ES20090TP	ES20100TP
Solid HPL 12mm** black core	5 kg	6,5 kg	8,5 kg	10,5 kg	13 kg	
	5,8 kg 0,03 m ³ 0,04 yd ³	7,5 kg 0,04 m ³ 0,05 yd ³	10,0 kg 0,05 m ³ 0,06 yd ³	11,9 kg 0,06 m ³ 0,08 yd ³	18 kg 0,07 m ³ 0,09 yd ³	
Solid FENIX® 12mm** black / black core	5 kg	6,5 kg	8,5 kg	11 kg	13,5 kg	
	5,8 kg 0,03 m ³ 0,04 yd ³	7,5 kg 0,04 m ³ 0,05 yd ³	10,0 kg 0,05 m ³ 0,06 yd ³	12,4 kg 0,06 m ³ 0,08 yd ³	18,5 kg 0,07 m ³ 0,09 yd ³	
Solid HPL 12mm** white / white core sand / sand core	5 kg	6,5 kg	8,5 kg	10,5 kg	13 kg	
	5,8 kg 0,03 m ³ 0,04 yd ³	7,5 kg 0,04 m ³ 0,05 yd ³	10,0 kg 0,05 m ³ 0,06 yd ³	11,9 kg 0,06 m ³ 0,08 yd ³	18 kg 0,07 m ³ 0,09 yd ³	
Solid HPL STONES 12mm**	5 kg	6,5 kg	8,5 kg	10,5 kg	13 kg	
	5,8 kg 0,03 m ³ 0,04 yd ³	7,5 kg 0,04 m ³ 0,05 yd ³	10,0 kg 0,05 m ³ 0,06 yd ³	11,9 kg 0,06 m ³ 0,08 yd ³	18 kg 0,07 m ³ 0,09 yd ³	

** The size of the HPL tops may have variations of ±1mm.

All prices listed in €. Taxes not included

Square table tops (for round base Ø38cm)

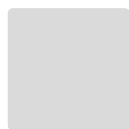

Table tops for tables with round bases 38cm.
The prices indicated below are only for the table tops.

Top size	60x60cm	70x70cm	80x80cm	90x90cm	
Top material	Code	ES20606TP	ES20707TP	ES20808TP	ES20909TP
Solid HPL 12mm** black core	208	244	282	322	
Solid FENIX® 12mm** black / black core	410	521	595	702	
Solid HPL 12mm** white / white core sand / sand core	410	521	595	702	
Solid HPL STONES 12mm**	451	574	655	773	

Table tops shipping data

Top size	60x60cm	70x70cm	80x80cm	90x90cm	
Top material	Code	ES20606TP	ES20707TP	ES20808TP	ES20909TP
Solid HPL 12mm** black core	5 kg 5,8 kg 0,03 m ³ 0,04 yd ³	8 kg 9,0 kg 0,04 m ³ 0,05 yd ³	10,5 kg 12,0 kg 0,05 m ³ 0,06 yd ³	13,5 kg 14,9 kg 0,06 m ³ 0,08 yd ³	
Solid FENIX® 12mm** black / black core	6,5 kg 7,3 kg 0,03 m ³ 0,04 yd ³	8,5 kg 9,5 kg 0,04 m ³ 0,05 yd ³	11 kg 12,5 kg 0,05 m ³ 0,06 yd ³	14 kg 15,4 kg 0,06 m ³ 0,08 yd ³	
Solid HPL 12mm** white / white core sand / sand core	5 kg 5,8 kg 0,03 m ³ 0,04 yd ³	8 kg 9,0 kg 0,04 m ³ 0,05 yd ³	10,5 kg 12,0 kg 0,05 m ³ 0,06 yd ³	13,5 kg 14,9 kg 0,06 m ³ 0,08 yd ³	
Solid HPL STONES 12mm**	5 kg 5,8 kg 0,03 m ³ 0,04 yd ³	8 kg 9,0 kg 0,04 m ³ 0,05 yd ³	10,5 kg 12,0 kg 0,05 m ³ 0,06 yd ³	13,5 kg 14,9 kg 0,06 m ³ 0,08 yd ³	

** The size of the HPL tops may have variations of ±1mm.

ESSENS

Round base 50cm (top not included)



 Ø120cm
 Ø140cm

 100x100cm
 120x120cm

Round polyethylene table base Ø50cm. This base allows to build tables with round tops of up to Ø140cm and square tops of up to 120x120cm. The inner counterweight must be acquired separately.

For this base we recommend a minimum inner counter weight of 60kg.

Finishes: in colours PE1, PE2, PE3 and PE5 from our rothomolded polyethylene swatch card.

Finishes book [+info](#)

Code	Colours PE1 standard	Colours PE2 composed	Colours PE3 standard painted	Colours PE4 metallic painted	Colours PE5 special RAL colours
ES10020BA	376	392	710	744	818

Code	Optional items & accessories	€
ES30013OP	Counterweight 60kg of gravel	55

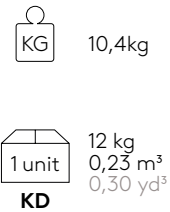
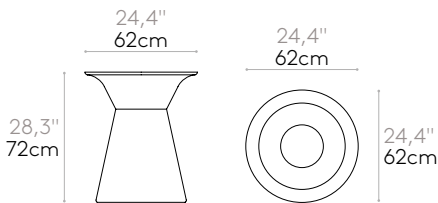

* Numbers may vary based on the exact options selected.
Only bases in B00 (black) and PE3 colours are made of 100% recycled PE.

Round table tops (for round base Ø50cm)



Top size		120cm	140cm
Top material	Code	ES20120TP	ES20140TP

Solid HPL
12mm** black core **582** **708**

Solid FENIX® 12mm**
black / black core **1.129** **1.570**

Solid HPL 12mm**
white / white core
sand / sand core **1.129** **1.570**

Solid HPL STONES
12mm** **1.242** **1.726**

Square table tops (for round base Ø50cm)

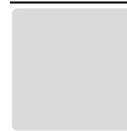

		100x100cm	120x120cm
		ES21010TP	ES21212TP

394 **597**



880 **1.140**



880 **1.140**



967 **1.255**



Table tops shipping data

Top size		120cm	140cm	100x100cm	120x120cm
Top material	Code	ES20120TP	ES20140TP	ES21010TP	ES21212TP

Solid HPL 12mm** black core		18,5 kg	25 kg	16,5 kg	23,5 kg
		25,3 kg 0,09 m ³ 0,12 yd ³	34 kg 0,12 m ³ 0,16 yd ³	21,5 kg 0,07 m ³ 0,09 yd ³	30,3 kg 0,09 m ³ 0,12 yd ³

Solid FENIX® 12mm** black / black core		19 kg	26 kg	17 kg	24 kg
		25,8 kg 0,09 m ³ 0,12 yd ³	35 kg 0,12 m ³ 0,16 yd ³	22 kg 0,07 m ³ 0,09 yd ³	26,2 kg 0,09 m ³ 0,12 yd ³

Solid HPL 12mm** white / white core sand / sand core		18,5 kg	25 kg	16,5 kg	23,5 kg
		25,3 kg 0,09 m ³ 0,12 yd ³	34 kg 0,12 m ³ 0,16 yd ³	21,5 kg 0,07 m ³ 0,09 yd ³	30,3 kg 0,09 m ³ 0,12 yd ³

Solid HPL STONES 12mm**		18,5 kg	25 kg	16,5 kg	23,5 kg
		25,3 kg 0,09 m ³ 0,12 yd ³	34 kg 0,12 m ³ 0,16 yd ³	21,5 kg 0,07 m ³ 0,09 yd ³	30,3 kg 0,09 m ³ 0,12 yd ³

** The size of the HPL tops may have variations of ±1mm.

ESSENS

Round base 65cm (top not included)



Round polyethylene table base Ø65cm. This base allows to build tables with round tops of up to Ø160cm and square tops of up to 140x140cm. The inner counterweight must be acquired separately.

For this base we recommend a minimum inner counter weight of 80kg.

Finishes: in colours PE1, PE2, PE3 and PE5 from our rothomolded polyethylene swatch card.

Finishes book [+info](#)

Code	Colours PE1 standard	Colours PE2 composed	Colours PE3 standard painted	Colours PE4 metallic painted	Colours PE5 special RAL colours
ES10050BA	632	656	1.063	1.103	1.234

Code	Optional items & accessories	€
ES30015OP	Counterweight 80kg of gravel	74

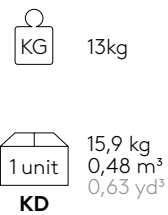
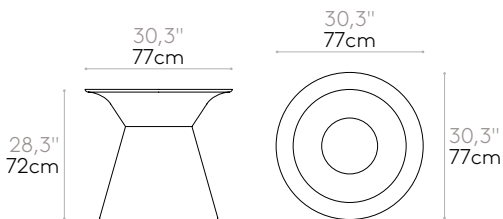

* Numbers may vary based on the exact options selected.
Only bases in B00 (black) and PE3 colours are made of 100% recycled PE.

Round table tops (for round base Ø65cm)



Top size	160cm
Top material	Code ES20160TP

Solid HPL
12mm** black core **1.000**

Solid FENIX® 12mm**
black / black core **1.938**

Solid HPL 12mm**
white / white core
sand / sand core **1.938**

Solid HPL STONES
12mm** **2.132**

Square table top (for round base Ø65cm)

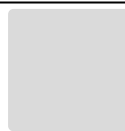

Top size	140x140cm
Top material	Code ES21414TP

708

1.585

1.585

1.744

Table tops shipping data

Top size	160cm	140x140cm
Top material	Code ES20160TP	Code ES21414TP
Solid HPL 12mm** black core	33 kg	32 kg
	44,4 kg 0,15 m ³ 0,20 yd ³	41 kg 0,12 m ³ 0,16 yd ³
Solid FENIX® 12mm** black / black core	34 kg	33 kg
	45,4 kg 0,15 m ³ 0,20 yd ³	42 kg 0,12 m ³ 0,16 yd ³
Solid HPL 12mm** white / white core sand / sand core	33 kg	32 kg
	44,4 kg 0,15 m ³ 0,20 yd ³	41 kg 0,12 m ³ 0,16 yd ³
Solid HPL STONES 12mm**	34 kg	33 kg
	45,4 kg 0,15 m ³ 0,20 yd ³	42 kg 0,12 m ³ 0,16 yd ³

** The size of the HPL tops may have variations of ±1mm.

ESSENS

Elliptical base (top not included)



Elliptical polyethylene table base. The inner counterweight must be acquired separately.

For this base we recommend a minimum inner counter weight of 100kg.

Finishes: in colours PE1, PE2, PE3 and PE5 from our rothomolded polyethylene swatch card.

Finishes book [+info](#)

Code	Colours PE1 standard	Colours PE2 composed	Colours PE3 standard painted	Colours PE4 metallic painted	Colours PE5 special RAL colours
ES10060BA	721	763	1.298	1.345	1.508

Code	Optional items & accessories	€
ES30017OP	Counterweight 100kg of gravel	92

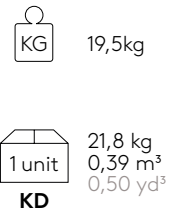
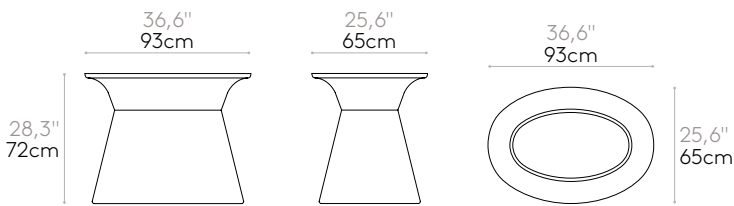

* Numbers may vary based on the exact options selected.
Only bases in B00 (black) and PE3 colours are made of 100% recycled PE.

Elliptical table tops (for elliptical base)



Table tops for tables with elliptical bases.

The prices indicated below are only for the table tops.

Top size	220x140cm	
Top material	Code	ES22214TE

Solid HPL
12mm** black core **1.367**

Solid FENIX® 12mm**
black / black core **2.671**

Solid HPL 12mm**
white / white core
sand / sand core **2.671**

Solid HPL STONES
12mm** **2.938**

Table tops shipping data

Top size	220x140cm	
Top material	Code	ES22214TE

Solid HPL
12mm** black core  41 kg

Solid HPL
12mm** black core  48,4 kg
0,14 m³
0,18 yd³

Solid FENIX® 12mm**
black / black core  42,5 kg

Solid FENIX® 12mm**
black / black core  49,9 kg
0,14 m³
0,18 yd³

Solid HPL 12mm**
white / white core  41 kg

Solid HPL 12mm**
white / white core
sand / sand core  48,4 kg
0,14 m³
0,18 yd³

Solid HPL STONES
12mm**  41 kg

Solid HPL STONES
12mm**  48,4 kg
0,14 m³
0,18 yd³

** The size of the HPL tops may have variations of ±1mm.

ESSENS

Oval base (top not included)



Oval polyethylene table base. The inner counterweight must be acquired separately.

For this base we recommend a minimum inner counter weight of 40kg.

Finishes: in colours PE1, PE2, PE3 and PE5 from our rothomolded polyethylene swatch card.

Finishes book [+info](#)

Code	Colours PE1 standard	Colours PE2 composed	Colours PE3 standard painted	Colours PE4 metallic painted	Colours PE5 special RAL colours
ES10030BA	348	365	673	711	781

Code	Optional items & accessories	€
ES30012OP	Counterweight 40kg of gravel	36



2 bases

With 2 bases: 200x100, 220x120 y 240x120.

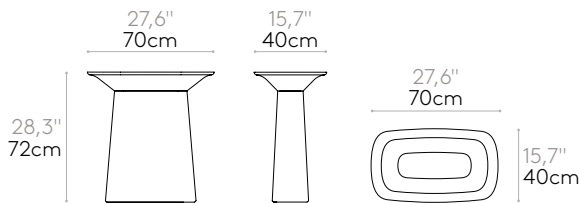

6,1kg



7,8 kg
0,21 m³
0,28 yd³

KD



Recycled*

* Numbers may vary based on the exact options selected.

Only bases in B00 (black) and PE3 colours are made of 100% recycled PE.

Oval table tops (for tables with 2 oval bases)







Table tops for tables with 2 oval bases.

The prices indicated below are only for the table tops.

Top size	200x100cm	220x120cm	240x120cm	
Top material	Code	ES22010TP	ES22212TP	ES22412TP
Solid HPL 12mm** black core	981	1.295	1.393	
Solid FENIX® 12mm** black / black core	1.882	2.267	2.598	
Solid HPL 12mm** white / white core sand / sand core	1.882	2.267	2.598	
Solid HPL STONES 12mm**	2.070	2.494	2.857	

Table tops shipping data

Top size	200x100cm	220x120cm	240x120cm
Code	ES22010TP	ES22212TP	ES22412TP
Solid HPL 12mm** black core	31 kg	41 kg	45 kg
	44,1 kg 0,09 m ³ 0,12 yd ³	59,3 kg 0,12 m ³ 0,16 yd ³	63,3 kg 0,13 m ³ 0,16 yd ³
Solid FENIX® 12mm** black / black core	32 kg	42,5 kg	46,5 kg
	45,1 kg 0,09 m ³ 0,12 yd ³	60,8 kg 0,12 m ³ 0,16 yd ³	64,8 kg 0,13 m ³ 0,16 yd ³
Solid HPL 12mm** white / white core sand / sand core	31 kg	41 kg	45 kg
	44,1 kg 0,09 m ³ 0,12 yd ³	59,3 kg 0,12 m ³ 0,16 yd ³	63,3 kg 0,13 m ³ 0,16 yd ³
Solid HPL STONES 12mm**	31 kg	41 kg	45 kg
	44,1 kg 0,09 m ³ 0,12 yd ³	59,3 kg 0,12 m ³ 0,16 yd ³	63,3 kg 0,13 m ³ 0,16 yd ³

** The size of the HPL tops may have variations of ±1mm.

ESSENS OCCASIONAL

FINISHES +info

Rotomolded polyethylene colours

PE1 colours standard colours

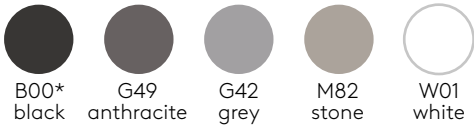

*B00 black 100% recycled material

PE2 colours composed colours



PE3 colours standard painted colours

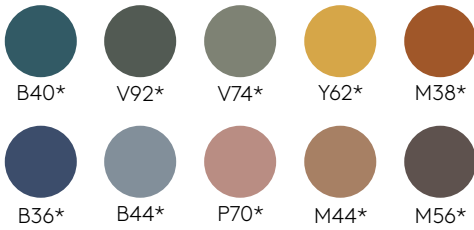

*100% recycled material

PE4 colours metallic painted colours



PE5 colours bespoke painted colours

OPTIONALLY, the bases can be painted in all the colours of the RAL sample card, both in gloss and matt finish.

Table tops

Solid FENIX® 12mm black core



Black

Solid HPL 12mm white core



White

Solid HPL 12mm sand core



Sand

Solid HPL STONES 12mm

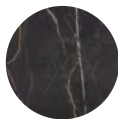

Dark brown
Samas
3482



Light brown
Pulpis
3447

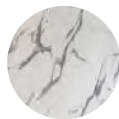

White
Olimpo
3493

TECHNICAL INFORMATION

Product data sheet [+info](#)

ENVIRONMENT & HEALTH

Product environmental data sheet [+info](#)

INCLASS production processes are certified according to environmental standards ISO 14001 in order to minimise any impact on the environment. ISO 14001 certificate [+info](#)

FIRE REQUIREMENTS

Please contact our Customer Service department if your project has specific flammability needs or if you need to know if all components comply with the required standards.

QUALITY STANDARDS

The quality management system of INCLASS is certified in accordance with ISO 9001 in all the design, manufacturing and sales procedures of its products. ISO 9001 certificate [+info](#)

COMPANY CERTIFICATIONS & ACCREDITATIONS

ISO 9001 - Quality management systems

ISO 14001 - Environmental management systems

FSC® - The mark of responsible forestry. Certificate C194846

AIDIMME Partner - Metal-processing, furniture, wood and packaging technology institute

IBV Partner - Valencia Institute of Biomechanics

ADVC Membership - Association of Designers of the Valencian Community

ENVALORA Membership - Collective System of Extended Producer Responsibility

WARRANTY 3 YEARS

Warranty conditions [+info](#)

ESSENS OCCASIONAL

Round base for coffe tables with height 40cm (top not included)



 Ø80cm
 Ø90cm
 Ø100cm



 110x70cm

Round polyethylene base Ø45cm for coffe tables with height 40cm. This base allows to build tables with round tops of up to Ø100cm and oval tops of 110x70cm. The inner counterweight is included.

Finishes: in colours PE1, PE2, PE3 and PE5 from our rothomolded polyethylene swatch card.

Finishes book [+info](#)

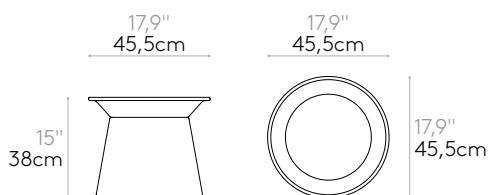
Code	Colours PE1 standard	Colours PE2 composed	Colours PE3 standard painted	Colours PE4 metallic painted	Colours PE5 special RAL colours
ES10110BA	266	282	521	531	572



 23,5kg

 24,3 kg
 0,09 m³
 0,11 yd³

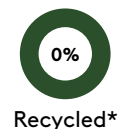
 0%
 Recycled*

* Numbers may vary based on the exact options selected.
Only bases in B00 (black) and PE3 colours are made of 100% recycled PE.

Round table tops (for round base Ø45cm)



	Top size	80cm	90cm	100cm
Top material	Code	ES20080TP	ES20090TP	ES20100TP

Solid FENIX®12mm**
black / black core

593

698

871

Solid HPL 12mm**
white / white core
sand / sand core

593

698

871

Solid HPL STONES
12mm**

653

768

959

Oval table top (for round base Ø45cm)



	110x70cm
Top material	Code
	ES21107TP

646

646

685

Table tops shipping data

	Top size	80cm	90cm	100cm	110x70cm
	Code	ES20080TP	ES20090TP	ES20100TP	ES21107TP
Solid FENIX® 12mm** black / black core		8,5 kg	11 kg	13,5 kg	11,2 kg
		10,0 kg 0,05 m ³ 0,06 yd ³	12,4 kg 0,06 m ³ 0,08 yd ³	18,5 kg 0,07 m ³ 0,09 yd ³	19,2 kg 0,06 m ³ 0,08 yd ³
		8,5 kg	10,5 kg	13 kg	10,8 kg
Solid HPL 12mm** white / white core sand / sand core		8,5 kg	10,5 kg	13 kg	10,8 kg
		10,0 kg 0,05 m ³ 0,06 yd ³	11,9 kg 0,06 m ³ 0,08 yd ³	18 kg 0,07 m ³ 0,09 yd ³	18,8 kg 0,06 m ³ 0,08 yd ³
		8,5 kg	10,5 kg	13 kg	10,8 kg
Solid HPL STONES 12mm**		8,5 kg	10,5 kg	13 kg	10,8 kg
		10,0 kg 0,05 m ³ 0,06 yd ³	11,9 kg 0,06 m ³ 0,08 yd ³	18 kg 0,07 m ³ 0,09 yd ³	18,8 kg 0,06 m ³ 0,08 yd ³
		8,5 kg	10,5 kg	13 kg	10,8 kg

** The size of the HPL tops may have variations of ±1mm.

ESSENS OCCASIONAL

Round base for side tables with height 44cm (top not included)



Round polyethylene base Ø22cm for side tables with height 44cm. This base allows to build tables with round tops of up to Ø50cm. The inner counterweight is included.

Finishes: in colours PE1, PE2, PE3 and PE5 from our rothomolded polyethylene swatch card.

Finishes book [+info](#)

Code	Colours PE1 standard	Colours PE2 composed	Colours PE3 standard painted	Colours PE4 metallic painted	Colours PE5 special RAL colours
ES10120BA	226	242	481	492	532

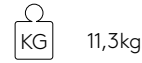
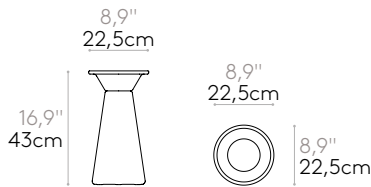

Round base for side tables with height 52cm (top not included)

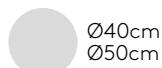

Round polyethylene base Ø22cm for side tables with height 52cm. This base allows to build tables with round tops of up to Ø50cm. The inner counterweight is included.

Finishes: in colours PE1, PE2, PE3 and PE5 from our rothomolded polyethylene swatch card.

Finishes book [+info](#)

Code	Colours PE1 standard	Colours PE2 composed	Colours PE3 standard painted	Colours PE4 metallic painted	Colours PE5 special RAL colours
ES10130BA	239	254	496	507	548

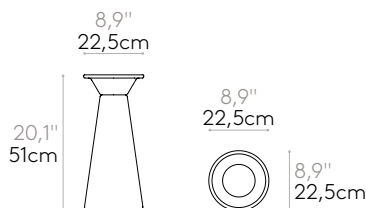







* Numbers may vary based on the exact options selected.
Only bases in B00 (black) and PE3 colours are made of 100% recycled PE.

Round table tops (for round base Ø22cm)



Top size		40cm	50cm
Top material	Code	ES20040TP	ES20050TP
Solid FENIX® 12mm** black / black core		195	262
Solid HPL 12mm** white / white core sand / sand core		195	262
Solid HPL STONES 12mm**		203	274

Table tops shipping data

Top size		40cm	50cm
Code		ES20040TP	ES20050TP
Solid FENIX® 12mm** black / black core		2,1 kg	3,8 kg
		2,5 kg 0,01 m ³ 0,01yd ³	4,5 kg 0,02 m ³ 0,03 yd ³
Solid HPL 12mm** white / white core sand / sand core		2 kg	3,7 kg
		2,4 kg 0,01 m ³ 0,01yd ³	4,4 kg 0,02 m ³ 0,03 yd ³
Solid HPL STONES 12mm**		2 kg	3,7 kg
		2,4 kg 0,01 m ³ 0,01yd ³	4,4 kg 0,02 m ³ 0,03 yd ³

** The size of the HPL tops may have variations of ±1mm.

FLOE

FINISHES +info

Base finishes

M1 colours



M2 colours

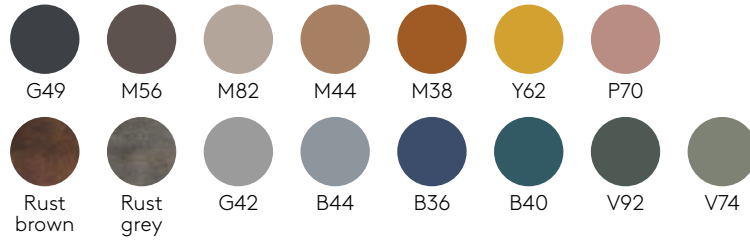

Table tops

Solid FENIX®

12mm black core



Black

Solid HPL

12mm black core



White



Black

Solid HPL

12mm white core



White

Solid HPL

12mm sand core



Sand

Solid HPL STONES

12mm

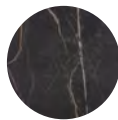

Dark brown
Samas
3482



Light brown
Pulpis
3447

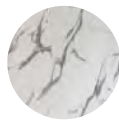

White
Olimpo
3493

TECHNICAL INFORMATION

Product data sheet [+info](#)

ENVIRONMENT & HEALTH

INCLASS production processes are certified according to environmental standards ISO 14001 in order to minimise any impact on the environment. ISO 14001 certificate [+info](#)

FIRE REQUIREMENTS

Please contact our Customer Service department if your project has specific flammability needs or if you need to know if all components comply with the required standards.

QUALITY STANDARDS

The quality management system of INCLASS is certified in accordance with ISO 9001 in all the design, manufacturing and sales procedures of its products. ISO 9001 certificate [+info](#)

COMPANY CERTIFICATIONS & ACCREDITATIONS

ISO 9001 - Quality management systems

ISO 14001 - Environmental management systems

FSC® - The mark of responsible forestry. Certificate C194846

AIDIMME Partner - Metal-processing, furniture, wood and packaging technology institute

IBV Partner - Valencia Institute of Biomechanics

ADVC Membership - Association of Designers of the Valencian Community

ENVALORA Membership - Collective System of Extended Producer Responsibility

WARRANTY 3 YEARS

Warranty conditions [+info](#)

FLOE OCCASIONAL

Side table 40x40cm with height 40cm



Side table with 40x40cm square top and aluminum base with height 40cm. The base plate is made of injected aluminum and it measures 32x32 cm. The central column is made of extruded aluminum.

Top finishes: table tops for outdoor use must be made of solid HPL. Please see our solid HPL table top collection.

Base finishes: micro-textured powder coated in colours M1 and M2 from our metallic swatch card.

Finishes book [+info](#)

Base finishes	Colours M1	Colours M2
Code	FLO0010	FLO0010

Shipping data

Solid HPL
12mm** black core

335

349



4,4kg



5,1 kg
0,02 m³
0,03 yd³

Solid FENIX® 12mm**
black / black core

408

422



4,5kg



5,2 kg
0,02 m³
0,03 yd³

Solid HPL 12mm**
white / white core
sand / sand core

421

435



4,4kg



5,1 kg
0,02 m³
0,03 yd³

Solid HPL STONES
12mm**

439

453



4,4kg



5,1 kg
0,02 m³
0,03 yd³

Upcharge
Counterweight
for side table

FLO0820 +40€

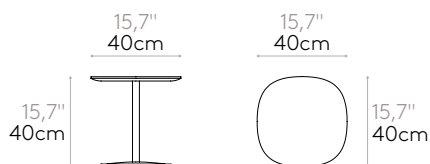

* Numbers may vary based on the exact options selected.

** The size of the HPL tops may have variations of ±1mm.

Side table 50x50cm with height 40cm



Side table with 50x50cm square top and aluminum base with height 40cm. The base plate is made of injected aluminum and it measures 32x32 cm. The central column is made of extruded aluminum.

Top finishes: table tops for outdoor use must be made of solid HPL. Please see our solid HPL table top collection.

Base finishes: micro-textured powder coated in colours M1 and M2 from our metallic swatch card.

Finishes book [+info](#)

Base finishes	Colours M1	Colours M2
Code	FLO0020	FLO0020

Shipping data

Solid HPL
12mm** black core

379

393



5,6kg



6,3 kg
0,02 m³
0,03 yd³

Solid FENIX® 12mm**
black / black core

445

459



5,7kg



6,4 kg
0,02 m³
0,03 yd³

Solid HPL 12mm**
white / white core
sand / sand core

462

476



5,6kg



6,3 kg
0,02 m³
0,03 yd³

Solid HPL STONES
12mm**

484

498



5,6kg



6,3 kg
0,02 m³
0,03 yd³

Upcharge
Counterweight
for side table

FLO0820 +40€

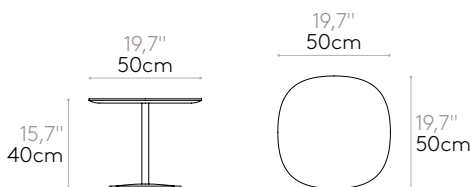

* Numbers may vary based on the exact options selected.

** The size of the HPL tops may have variations of ±1mm.

FLOE OCCASIONAL

Side table 51x38cm with height 40cm



Side table with 51x38cm square top and aluminum base with height 40cm. The base plate is made of injected aluminum and it measures 32x32 cm. The central column is made of extruded aluminum.

Top finishes: table tops for outdoor use must be made of solid HPL. Please see our solid HPL table top collection.

Base finishes: micro-textured powder coated in colours M1 and M2 from our metallic swatch card.

Finishes book [+info](#)

Base finishes	Colours M1	Colours M2
Code	FLO0030	FLO0030

Shipping data

Solid HPL
12mm** black core

343

357



5,1kg



5,8 kg
0,02 m³
0,03 yd³

Solid FENIX® 12mm**
black / black core

399

413



5,3kg



6 kg
0,02 m³
0,03 yd³

Solid HPL 12mm**
white / white core
sand / sand core

411

425



5,1kg



5,8 kg
0,02 m³
0,03 yd³

Solid HPL STONES
12mm**

389

403



5,1kg



5,8 kg
0,02 m³
0,03 yd³

Upcharge
Counterweight
for side table

FLO0820 +40€



* Numbers may vary based on the exact options selected.

** The size of the HPL tops may have variations of ±1mm.

All prices listed in €. Taxes not included

Side table 40x40cm with height 50cm



Side table with 40x40cm square top and aluminum base with height 50cm. The base plate is made of injected aluminum and it measures 32x32 cm. The central column is made of extruded aluminum.

Top finishes: table tops for outdoor use must be made of solid HPL. Please see our solid HPL table top collection.

Base finishes: micro-textured powder coated in colours M1 and M2 from our metallic swatch card.

Finishes book [+info](#)

Base finishes	Colours M1	Colours M2
Code	FLO0110	FLO0110

Shipping data

Solid HPL
12mm** black core

339

353



4,5kg



5,2 kg
0,02 m³
0,03 yd³

Solid FENIX® 12mm**
black / black core

412

426



4,6kg



5,3 kg
0,02 m³
0,03 yd³

Solid HPL 12mm**
white / white core
sand / sand core

425

439



4,5kg



5,2 kg
0,02 m³
0,03 yd³

Solid HPL STONES
12mm**

443

457



4,5kg



5,2 kg
0,02 m³
0,03 yd³

Upcharge
Counterweight
for side table

FLO0820 +40€

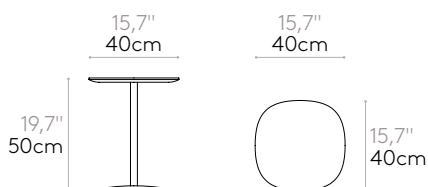

* Numbers may vary based on the exact options selected.

** The size of the HPL tops may have variations of ±1mm.

FLOE OCCASIONAL

Side table 50x50cm with height 50cm



Side table with 50x50cm square top and aluminum base with height 50cm. The base plate is made of injected aluminum and it measures 32x32 cm. The central column is made of extruded aluminum.

Top finishes: table tops for outdoor use must be made of solid HPL. Please see our solid HPL table top collection.

Base finishes: micro-textured powder coated in colours M1 and M2 from our metallic swatch card.

Finishes book [+info](#)

Base finishes	Colours M1	Colours M2
Code	FLO0120	FLO0120

Shipping data

Solid HPL
12mm** black core

383

397



5,8kg



6,4 kg
0,02 m³
0,03 yd³

Solid FENIX® 12mm**
black / black core

449

463



5,9kg



6,5 kg
0,02 m³
0,03 yd³

Solid HPL 12mm**
white / white core
sand / sand core

465

479



5,8kg



6,4 kg
0,02 m³
0,03 yd³

Solid HPL STONES
12mm**

487

501



5,8kg



6,4 kg
0,02 m³
0,03 yd³

Upcharge
Counterweight
for side table

FLO0820 +40€

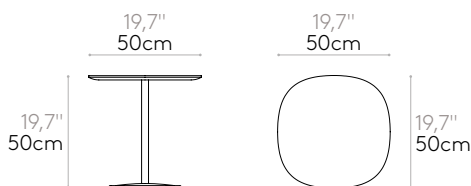

* Numbers may vary based on the exact options selected.

** The size of the HPL tops may have variations of ±1mm.

Side table 51x38cm with height 50cm



Side table with 51x38cm square top and aluminum base with height 50cm. The base plate is made of injected aluminum and it measures 32x32 cm. The central column is made of extruded aluminum.

Top finishes: table tops for outdoor use must be made of solid HPL. Please see our solid HPL table top collection.

Base finishes: micro-textured powder coated in colours M1 and M2 from our metallic swatch card.

Finishes book [+info](#)

Base finishes	Colours M1	Colours M2
Code	FLO0130	FLO0130

Shipping data

Solid HPL
12mm** black core

347

361



5,3kg



6 kg
0,02 m³
0,03 yd³

Solid FENIX® 12mm**
black / black core

403

417



5,4kg



6,1 kg
0,02 m³
0,03 yd³

Solid HPL 12mm**
white / white core
sand / sand core

415

429



5,3kg



6 kg
0,02 m³
0,03 yd³

Solid HPL STONES
12mm**

393

407



5,3kg



6 kg
0,02 m³
0,03 yd³

Upcharge
Counterweight
for side table

FLO0820 +40€



* Numbers may vary based on the exact options selected.

** The size of the HPL tops may have variations of ±1mm.

FLOE OCCASIONAL

Laptop table 58x36cm with height 66cm



Side table with 58x36cm oval top and aluminum base with height 66cm. The base plate is made of injected aluminum and it measures 45x23,5cm. The central column is made of extruded aluminum.

Top finishes: table tops for outdoor use must be made of solid HPL. Please see our solid HPL table top collection.

Base finishes: micro-textured powder coated in colours M1 and M2 from our metallic swatch card.

Finishes book [+info](#)

Base finishes	Colours M1	Colours M2
Code	FLO0340	FLO0340

Shipping data

Solid HPL
12mm** black core

293

307



5,1kg



5,8 kg
0,02 m³
0,03 yd³

Solid FENIX® 12mm**
black / black core

358

372



5,3kg



6 kg
0,02 m³
0,03 yd³

Solid HPL 12mm**
white / white core
sand / sand core

369

383



5,1kg



5,8 kg
0,02 m³
0,03 yd³

Solid HPL STONES
12mm**

325

339



5,1kg



5,8 kg
0,02 m³
0,03 yd³

Upcharge
Counterweight
for laptop table

FLO0830 +46€

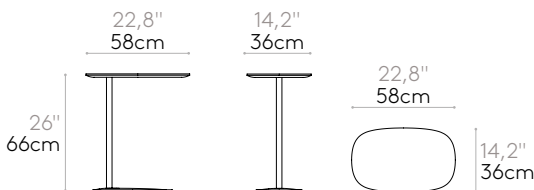

* Numbers may vary based on the exact options selected.

** The size of the HPL tops may have variations of ±1mm.

Table base 48x48cm with height 103cm (top not included)

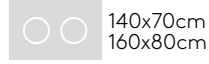
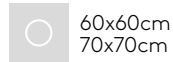

Aluminum table base with height 38cm. The base plate is made of injected aluminum and it measures 48x48cm. The central column is made of extruded aluminum. The table top is not included.

Base finishes: micro-textured powder coated in colours M1 and M2 from our metallic swatch card.

Finishes book [+info](#)

Code	Base	€
FLO0430	Colours M1	272
FLO0430	Colours M2	299
FLO0840	Counterweight	+70€

Recommended counterweight for tabletops: Ø80cm, 70x70cm, 180x90cm and 160x80cm.

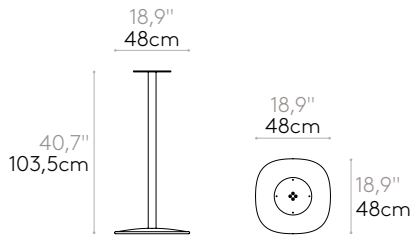

7kg



8,2 kg
0,08 m³
0,10 yd³



43%
Recycled*

* Numbers may vary based on the exact options selected.

FLOE CAFE

Table base 48x48cm with height 73cm (top not included)

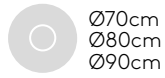

Ø70cm
Ø80cm
Ø90cm

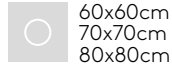

60x60cm
70x70cm
80x80cm



180x90cm



140x70cm
160x80cm

Aluminum table base with height 73cm. The base plate is made of injected aluminum and it measures 48x48cm. The central column is made of extruded aluminum. The table top is not included.

Base finishes: micro-textured powder coated in colours M1 and M2 from our metallic swatch card.

Finishes book [+info](#)

Code	Base	€
FLO0420	Colours M1	258
FLO0420	Colours M2	284
FLO0840	Counterweight	+70€

Recommended counterweight for tabletops: Ø90cm, 80x80cm and 180x90cm.

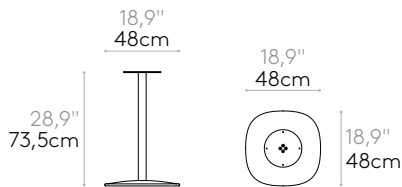

6,5kg



7,5 kg
0,05 m³
0,06 yd³

KD



Recycled*

* Numbers may vary based on the exact options selected.

All prices listed in €. Taxes not included

Table base 48x48cm with height 38cm (top not included)



Ø70cm
Ø80cm
Ø90cm

60x60cm
70x70cm
80x80cm



110x60cm

Aluminum table base with height 38cm. The base plate is made of injected aluminum and it measures 48x48cm. The central column is made of extruded aluminum. The table top is not included.

Base finishes: micro-textured powder coated in colours M1 and M2 from our metallic swatch card.

Finishes book [+info](#)

Code	Base	€
FLO0410	Colours M1	239
FLO0410	Colours M2	263
FLO0840	Counterweight	+70€ <i>Recommended counterweight for tabletops: 110x60cm</i>

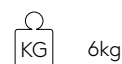
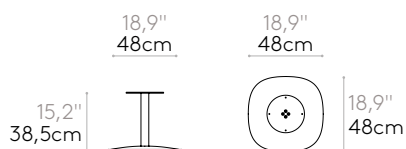

6kg



7 kg
0,04 m³
0,05 yd³

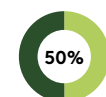

Recycled*

* Numbers may vary based on the exact options selected.





FLOE CAFE

Round table tops



Top size	70cm	80cm	90cm
Code	TAP0070TP	TAP0080TP	TAP0090TP
Solid HPL 12mm** black core	242	279	326
Solid FENIX® 12mm** black / black core	512	593	698
Solid HPL 12mm** white / white core sand / sand core	512	593	698
Solid HPL STONES 12mm**	563	653	768

Table tops shipping data

Top size	70cm	80cm	90cm
Code	TAP0070TP	TAP0080TP	TAP0090TP
Solid HPL 12mm* black core	6,5 kg	8,5 kg	10,5kg
	7,5 kg 0,04 m ³ 0,05 yd ³	10,0 kg 0,05 m ³ 0,06 yd ³	11,9 kg 0,06 m ³ 0,08 yd ³
Solid FENIX® 12mm* black / black core	6,5 kg	8,5 kg	11kg
	7,5 kg 0,04 m ³ 0,05 yd ³	10,0 kg 0,05 m ³ 0,06 yd ³	12,4 kg 0,06 m ³ 0,08 yd ³
Solid HPL 12mm* white / white core sand / sand core	6,5 kg	8,5 kg	10,5kg
	7,5 kg 0,04 m ³ 0,05 yd ³	10,0 kg 0,05 m ³ 0,06 yd ³	11,9 kg 0,06 m ³ 0,08 yd ³
Solid HPL STONES 12mm*	6,5 kg	8,5 kg	10,5kg
	7,5 kg 0,04 m ³ 0,05 yd ³	10,0 kg 0,05 m ³ 0,06 yd ³	11,9 kg 0,06 m ³ 0,08 yd ³

** The size of the HPL tops may have variations of ±1mm.









All prices listed in €. Taxes not included

Square table tops



Top size	60x60cm	70x70cm	80x80cm	
Top finish	Code	TAP0606TP	TAP0707TP	TAP0808TP
Solid HPL 12mm** black core	208	244	282	
Solid FENIX® 12mm** black / black core	410	521	595	
Solid HPL 12mm** white / white core sand / sand core	410	521	595	
Solid HPL STONES 12mm**	451	574	655	

Table tops shipping data

Top size	60x60cm	70x70cm	80x80cm
Code	TAP0606TP	TAP0707TP	TAP0808TP
	6kg	8kg	10,5kg
Solid HPL 12mm* black core	6,8 kg 0,03 m ³ 0,04 yd ³	9,0 kg 0,04 m ³ 0,05 yd ³	12,0 kg 0,05 m ³ 0,06 yd ³
			
	6kg	8,5kg	11kg
Solid FENIX® 12mm* black / black core	6,8 kg 0,03 m ³ 0,04 yd ³	9,5 kg 0,04 m ³ 0,05 yd ³	12,5 kg 0,05 m ³ 0,06 yd ³
			
	6kg	8kg	10,5kg
Solid HPL 12mm* white / white core sand / sand core	6,8 kg 0,03 m ³ 0,04 yd ³	9,0 kg 0,04 m ³ 0,05 yd ³	12,0 kg 0,05 m ³ 0,06 yd ³
			
	6kg	8kg	10,5kg
Solid HPL STONES 12mm*	6,8 kg 0,03 m ³ 0,04 yd ³	9,0 kg 0,04 m ³ 0,05 yd ³	12,0 kg 0,05 m ³ 0,06 yd ³
			

** The size of the HPL tops may have variations of ±1mm.









FLOE CAFE

Rectangular table tops



Top size	140x70cm	160x80cm
Top finish	Code	Code
	TAP1407TP	TAP1608TP
Solid HPL 12mm** black core	522	569
Solid FENIX® 12mm** black / black core	1.039	1.131
Solid HPL 12mm** white / white core sand / sand core	1.039	1.131
Solid HPL STONES 12mm**	1.143	1.244

Table tops shipping data

Top size	140x70cm	160x80cm
Code	TAP1407TP	TAP1608TP
Solid HPL 12mm** black core	15,9 kg	21 kg
 	25,3 kg 0,07 m ³ 0,09 yd ³	32,6 kg 0,09 m ³ 0,12 yd ³
Solid FENIX® 12mm** black core	16,5 kg	21,5 kg
 	25,9 kg 0,07 m ³ 0,09 yd ³	33,1 kg 0,09 m ³ 0,12 yd ³
Solid HPL 12mm** white / white core sand / sand core	15,9 kg	21 kg
 	25,3 kg 0,07 m ³ 0,09 yd ³	32,6 kg 0,09 m ³ 0,12 yd ³
Solid HPL STONES 12mm**	15,9 kg	21 kg
 	25,3 kg 0,07 m ³ 0,09 yd ³	32,6 kg 0,09 m ³ 0,12 yd ³

** The size of the HPL tops may have variations of ±1mm.

All prices listed in €. Taxes not included

Oval table tops



Top size	110x60cm	180x90cm	
Top finish	Code	TAP1106TO	TAP1809TO

Solid HPL
12mm** black core

294

703

Solid FENIX® 12mm**
black / black core

567

1.468

Solid HPL 12mm**
white / white core
sand / sand core

567









1.468

Solid HPL STONES
12mm**

652

1.615

Table tops shipping data

Top size	110x60cm	180x90cm
Code	TAP1106TO	TAP1809TO
Solid HPL 12mm** black core	9,5 kg	23,5 kg
	16,8 kg	30,6 kg
	0,05 m ³ 0,06 yd ³	0,20 m ³ 0,26 yd ³
Solid FENIX® 12mm** black core	9,9 kg	24,5 kg
	17,2 kg	31,6 kg
	0,05 m ³ 0,06 yd ³	0,20 m ³ 0,26 yd ³
Solid HPL 12mm** white / white core sand / sand core	9,5 kg	23,5 kg
	16,8 kg	30,6 kg
	0,05 m ³ 0,06 yd ³	0,20 m ³ 0,26 yd ³
Solid HPL STONES 12mm**	9,5 kg	23,5 kg
	16,8 kg	30,6 kg
	0,05 m ³ 0,06 yd ³	0,20 m ³ 0,26 yd ³

** The size of the HPL tops may have variations of ±1mm.

LAMINAR

FINISHES +info

Aluminum frames

M1 colours



M2 colours

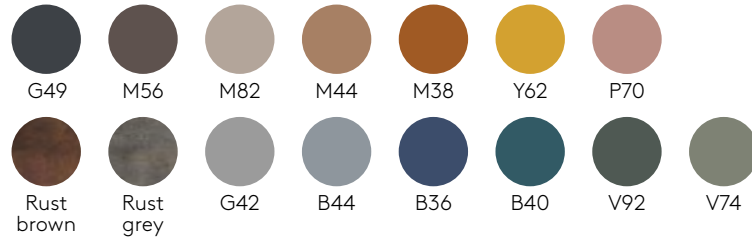

Table tops

Solid FENIX®

12mm black core



Black

Solid HPL

12mm black core



White



Black

Solid HPL

12mm white core



White

Solid HPL

12mm sand core



Sand

Solid HPL STONES

12mm

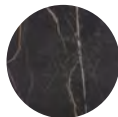

Dark brown
Samas
3482



Light brown
Pulpis
3447

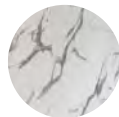

White
Olimpo
3493

TECHNICAL INFORMATION

Product data sheet [+info](#)

ENVIRONMENT & HEALTH

Product environmental data sheet [+info](#)

INCLASS production processes are certified according to environmental standards ISO 14001 in order to minimise any impact on the environment. ISO 14001 certificate [+info](#)

FIRE REQUIREMENTS

Please contact our Customer Service department if your project has specific flammability needs or if you need to know if all components comply with the required standards.

QUALITY STANDARDS

The quality management system of INCLASS is certified in accordance with ISO 9001 in all the design, manufacturing and sales procedures of its products. ISO 9001 certificate [+info](#)

PRODUCT CERTIFICATIONS

UNE-EN 527-1:2011

UNE-EN 527-2:2017+A1:2019

UNE-EN 15372:2017

ANSI BIFMA X5.5:2021

INCLASS products have been extensively tested to exceed industry testing standards at AIDIMME. AIDIMME is member of the European network INNOVAWOOD and its testing laboratories are accredited by ENAC.

COMPANY CERTIFICATIONS & ACCREDITATIONS

ISO 9001 - Quality management systems

ISO 14001 - Environmental management systems

FSC® - The mark of responsible forestry. Certificate C194846

AIDIMME Partner - Metal-processing, furniture, wood and packaging technology institute

IBV Partner - Valencia Institute of Biomechanics

ADVC Membership - Association of Designers of the Valencian Community

ENVALORA Membership - Collective System of Extended Producer Responsibility

WARRANTY 3 YEARS

Warranty conditions [+info](#)

LAMINAR

Tables height 75cm



Table with rectangular table top. The frame and legs are made of extruded aluminum. Height 75cm.

Top finishes: table tops for outdoor use must be made of solid HPL. Please see our solid HPL table top collection.

Frame finishes: micro-textured powder coated in colours M1 and M2 from our metallic swatch card.

Glides: plastic glides as standard.

Finishes book [+info](#)

Size	60x120cm		70x140cm		80x80cm		80x160cm		80x180cm		80x200cm	
Code	LAM0612		LAM0714		LAM0808		LAM0816		LAM0818		LAM0820	
Top finish	M1***	M2***	M1***	M2***	M1***	M2***	M1***	M2***	M1***	M2***	M1***	M2***
Solid HPL 12mm** black core	1.031	1.072	1.168	1.214	943	982	1.340	1.394	1.432	1.489	1.496	1.555
Solid FENIX® 12mm** black / black core	1.395	1.450	1.654	1.720	1.225	1.274	1.969	2.048	2.137	2.223	2.325	2.417
Solid HPL 12mm** white / white core sand / sand core	1.395	1.450	1.654	1.720	1.225	1.274	1.969	2.048	2.137	2.223	2.325	2.417
Solid HPL STONES 12mm**	1.492	1.552	1.770	1.841	1.310	1.364	2.107	2.191	2.287	2.378	2.487	2.586

Optional items & accessories

Code	Upcharge	Colours M1	Colours M2
LAM9090	Set of 2 legs height 90cm	23	25
LAM9105	Set of 2 legs height 105cm	44	48

Table tops shipping data

Top size	60x120cm	70x140cm	80x80cm	80x160cm	80x180cm	80x200cm
Code	LAM0612	LAM0714	LAM0808	LAM0816	LAM0818	LAM0820
Solid HPL 12mm** black core	28 kg	33,7 kg	25,7 kg	40 kg	43,6 kg	47,2 kg
	32,3 kg 0,10 m ³ 0,13 yd ³	38,2 kg 0,13 m ³ 0,17 yd ³	29,8 kg 0,10 m ³ 0,13 yd ³	45,9 kg 0,17 m ³ 0,22 yd ³	49,6 kg 0,19 m ³ 0,25 yd ³	56,2 kg 0,21 m ³ 0,27 yd ³
Solid FENIX® 12mm** black / black core	28,4 kg	34,3 kg	26,1 kg	40,8 kg	44,5 kg	48,1 kg
	32,7 kg 0,10 m ³ 0,13 yd ³	38,8 kg 0,13 m ³ 0,17 yd ³	30,2 kg 0,10 m ³ 0,13 yd ³	46,7 kg 0,17 m ³ 0,22 yd ³	50,5 kg 0,19 m ³ 0,25 yd ³	60,7 kg 0,21 m ³ 0,27 yd ³
Solid HPL 12mm** white / white core sand / sand core	28 kg	33,7 kg	25,7 kg	40 kg	43,6 kg	47,2 kg
	32,3 kg 0,10 m ³ 0,13 yd ³	38,2 kg 0,13 m ³ 0,17 yd ³	29,8 kg 0,10 m ³ 0,13 yd ³	45,9 kg 0,17 m ³ 0,22 yd ³	49,6 kg 0,19 m ³ 0,25 yd ³	56,2 kg 0,21 m ³ 0,27 yd ³
Solid HPL STONES 12mm**	28 kg	33,7 kg	25,7 kg	40 kg	43,6 kg	47,2 kg
	32,3 kg 0,10 m ³ 0,13 yd ³	38,2 kg 0,13 m ³ 0,17 yd ³	29,8 kg 0,10 m ³ 0,13 yd ³	45,9 kg 0,17 m ³ 0,22 yd ³	49,6 kg 0,19 m ³ 0,25 yd ³	56,2 kg 0,21 m ³ 0,27 yd ³

** La medida de los sobros de HPL pueden tener una variación de ±1mm.

*** Indicar el color del marco y las partes metálicas

All prices listed in €. Taxes not included

Tables height 75cm



Table with rectangular table top. The frame and legs are made of extruded aluminum. Height 75cm.

Top finishes: table tops for outdoor use must be made of solid HPL. Please see our solid HPL table top collection.

Frame finishes: micro-textured powder coated in colours M1 and M2 from our metallic swatch card.

Glides: plastic glides as standard.

Finishes book [+info](#)

Size	90x90cm	90x180cm	90x200cm	90x240	100x100cm	120x120cm	120x200cm	120x240cm	120x280cm
Code	LAM0909	LAM0918	LAM0920	LAM0924	LAM1010	LAM1212	LAM1220	LAM1224	LAM1228
Top finish	M1*** M2***	M1*** M2***	M1*** M2***	M1*** M2***	M1*** M2***	M1*** M2***	M1*** M2***	M1*** M2***	M1*** M2***
Solid HPL 12mm** black core	1.051 1.093	1.512 1.573	1.654 1.720	1.846 1.920	1.151 1.197	1.358 1.412	1.908 1.984	2.152 2.238	2.372 2.467
Solid FENIX® 12mm** black / black core	1.441 1.499	2.353 2.446	2.709 2.817	3.122 3.247	1.688 1.756	2.175 2.262	3.285 3.417	3.867 4.021	4.356 4.530
Solid HPL 12mm** white / white core sand / sand core	1.441 1.499	2.353 2.446	2.709 2.817	3.122 3.247	1.688 1.756	2.175 2.262	3.285 3.417	3.867 4.021	4.356 4.530
Solid HPL STONES 12mm**	1.542 1.604	2.517 2.617	2.898 3.014	3.340 3.474	1.807 1.879	2.328 2.421	3.514 3.655	4.138 4.302	4.661 4.847

Optional items & accessories

Code	Upcharge	Colours M1	Colours M2
LAM9090	Set of 2 legs height 90cm ****	23	25
LAM9105	Set of 2 legs height 105cm ****	44	48

Table tops shipping data

Top size	90x90cm	90x180cm	90x200cm	90x240cm	100x100cm	120x120cm	120x200cm	120x240cm	120x280cm
Code	LAM0909	LAM0918	LAM0920	LAM0924	LAM1010	LAM1212	LAM1220	LAM1224	LAM1228
Solid HPL 12mm** black core	29,4 kg 33,7 kg 0,11 m ³ 0,14 yd ³	47 kg 53,4 kg 0,21 m ³ 0,27 yd ³	50,9 kg 59,1 kg 0,23 m ³ 0,30 yd ³	58,7 kg 67,1 kg 0,28 m ³ 0,37 yd ³	33,5 kg 37,9 kg 0,13 m ³ 0,17 yd ³	42,6 kg 48,9 kg 0,18 m ³ 0,24 yd ³	62,1 kg 70,7 kg 0,30 m ³ 0,39 yd ³	71,9 kg 80,7 kg 0,36 m ³ 0,47 yd ³	80,1 kg 87,5 kg 0,42 m ³ 0,55 yd ³
Solid FENIX® 12mm** black / black core	29,9 kg 34,2 kg 0,11 m ³ 0,14 yd ³	48 kg 54,4 kg 0,21 m ³ 0,27 yd ³	52 kg 60,2 kg 0,23 m ³ 0,30 yd ³	60 kg 68,4 kg 0,28 m ³ 0,37 yd ³	34,1 kg 38,5 kg 0,13 m ³ 0,17 yd ³	43,5 kg 49,8 kg 0,18 m ³ 0,24 yd ³	63,5 kg 72,1 kg 0,30 m ³ 0,39 yd ³	73,6 kg 82,4 kg 0,36 m ³ 0,47 yd ³	82,1 kg 89,5 kg 0,42 m ³ 0,55 yd ³
Solid HPL 12mm** white / white core sand / sand core	29,4 kg 33,7 kg 0,11 m ³ 0,14 yd ³	47 kg 53,4 kg 0,21 m ³ 0,27 yd ³	50,9 kg 59,1 kg 0,23 m ³ 0,30 yd ³	58,7 kg 67,1 kg 0,28 m ³ 0,37 yd ³	33,5 kg 37,9 kg 0,13 m ³ 0,17 yd ³	42,6 kg 48,9 kg 0,18 m ³ 0,24 yd ³	62,1 kg 70,7 kg 0,30 m ³ 0,39 yd ³	71,9 kg 80,7 kg 0,36 m ³ 0,47 yd ³	80,1 kg 87,5 kg 0,42 m ³ 0,55 yd ³
Solid HPL STONES 12mm**	29,4 kg 33,7 kg 0,11 m ³ 0,14 yd ³	47 kg 53,4 kg 0,21 m ³ 0,27 yd ³	50,9 kg 59,1 kg 0,23 m ³ 0,30 yd ³	58,7 kg 67,1 kg 0,28 m ³ 0,37 yd ³	33,5 kg 37,9 kg 0,13 m ³ 0,17 yd ³	42,6 kg 48,9 kg 0,18 m ³ 0,24 yd ³	62,1 kg 70,7 kg 0,30 m ³ 0,39 yd ³	71,9 kg 80,7 kg 0,36 m ³ 0,47 yd ³	80,1 kg 87,5 kg 0,42 m ³ 0,55 yd ³

** La medida de los sobres de HPL pueden tener una variación de ±1mm.

*** Indicar el color del marco y las partes metálicas

**** Las mesas con medidas 90x240cm, 120x240cm y 120x280cm se montan como las mesas seccionales con dos sobres.

LAMINAR

Tables with round table tops height 75cm



Table with round table top. The frame and legs are made of extruded aluminum. Height 75cm.

Top finishes: table tops for outdoor use must be made of solid HPL. Please see our solid HPL table top collection.

Frame finishes: micro-textured powder coated in colours M1 and M2 from our metallic swatch card.

Glides: plastic glides as standard.

Finishes book [+info](#)

Size	Ø100cm		Ø120cm	
Code	LAM0100		LAM0120	
Top finish	M1***	M2***	M1***	M2***
Solid HPL 12mm** black core	1.049	1.091	1.218	1.267
FENIX® laminate 14mm**	1.489	1.549	1.832	1.906
Solid HPL 12mm** white / white core sand / sand core	1.489	1.549	1.832	1.906
Solid HPL STONES 12mm**	1.593	1.657	1.961	2.039

Optional items & accessories









Code	Upcharge	Colours M1	Colours M2
LAM9090	Set of 2 legs height 90cm	23	25
LAM9105	Set of 2 legs height 105cm	44	48

** The size of the HPL tops may have variations of ±1mm.

*** Indicate the colour of the metal parts.

All prices listed in €. Taxes not included

Table tops shipping data

Top size		Ø100cm	Ø120cm
Code		LAM0100	LAM0120
Solid HPL 12mm** black core		28,1 kg	28,6 kg
		32,5 kg 0,13 m ³ 0,17 yd ³	33 kg 0,18 m ³ 0,24 yd ³
Solid FENIX® 12mm** black / black core		35,2 kg	35,9 kg
		41,5 kg 0,13 m ³ 0,17 yd ³	42,2 kg 0,18 m ³ 0,24 yd ³
Solid HPL 12mm** white / white core sand / sand core		28,1 kg	28,6 kg
		32,5 kg 0,13 m ³ 0,17 yd ³	33 kg 0,18 m ³ 0,24 yd ³
Solid HPL STONES 12mm**		28,1 kg	28,6 kg
		32,5 kg 0,13 m ³ 0,17 yd ³	33 kg 0,18 m ³ 0,24 yd ³

** The size of the HPL tops may have variations of ±1mm.

*** Indicate the colour of the metal parts.